

Straight Run Single Hinge RubberTop®

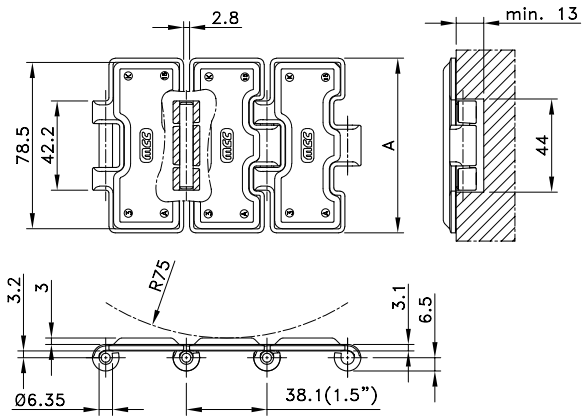

Chain Type	Code Number	Plate Width		Weight	Polished Hinge Eyes	Working Load (max.)
		A				
		mm	inch	kg/m		N
66-Series						
66 S 31 R	762.04.31	82.5	3.25	2.80	no	6000

Standard length: 3.048 m - 10 feet (80 links).

NS 815

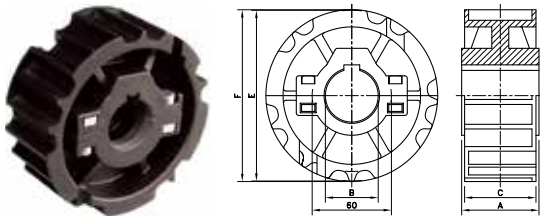

Sprocket Type	Code Number	Number of Teeth	Bore	Pitch Diameter	Outside Diameter	Width (Teeth)	Hub Width	Hub Diameter
			B mm/inch	E mm	F mm	C mm	A mm	H mm

Split Sprockets, Injection Moulded - NS 815

Metric Bores

NS815 21-25	L0815663881	21	25	129.3	129.5	52	51	60
NS815 21-30	L0815663891	21	30					
NS815 21-35	L0815663901	21	35					
NS815 21-40	L0815663911	21	40					
NS815 21-45	L0815663921	21	45					
NS815 23-25	L0815662481	23	25	141.2	142.0	52	51	
NS815 23-30	L0815662491	23	30					
NS815 23-35	L0815662501	23	35					
NS815 23-40	L0815662511	23	40					
NS815 23-45	L0815662521	23	45	153.2	154.2	54.0	58.5	
NS815 25-25	L0815665331	25	25					
NS815 25-30	L0815665311	25	30					
NS815 25-35	L0815665341	25	35					
NS815 25-40	L0815664931	25	40					
NS815 25-45	L0815665351	25	45					

Inch Bores

NS815 21-1	L0815663931	21	1.00"	129.3	129.5	52.0	51.0	60
NS815 21-1¼	L0815663991	21	1.25"					
NS815 23-1	L0815662661	23	1.00"	141.2	142.0	52.0	51.0	
NS815 23-1¼	L0815662701	23	1.25"					
NS815 25-1	L0815665411	25	1.00"	153.2	154.2	54.0	58.5	
NS815 25-1¼	L0815665451	25	1.25"					
NS815 25-1½	L0815665491	25	1.50"					

For steel chain series: **Rexnord**: 812 (except TAB and mini hinge), 815.

MCC: single hinge straight run, single hinge Magnetflex. Note: not for heavy duty tab.

* Ask customer service for minimum order quantity.

NSH 815

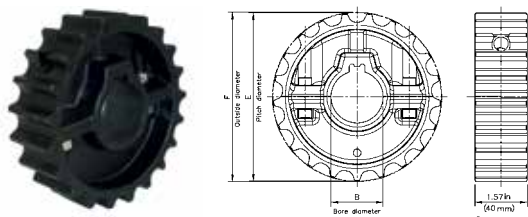

Sprocket Type	Code Number	Number of Teeth	Pitch Diameter	Outside Diameter	Width	Hub Width	Shaft Size	Equivalent of KUS 815
			in-mm	in-mm	in-mm	in-mm	in-mm	
Split moulded sprocket NSH 815								
NSH 815T21R30	754.70.03	21	5.09 / 129.3	5.11 / 130.0	1.57 / 40	1.57 / 40	1.18 / 30	753.62.23
NSH 815T21R40	754.70.00	21	5.09 / 129.3	5.11 / 130.0	1.57 / 40	1.57 / 40	1.57 / 40	753.62.43
NSH 815T25R40	754.70.06	25	6.03 / 153.2	6.05 / 153.9	1.57 / 40	1.57 / 40	1.57 / 40	753.62.45
Split moulded sprocket NSH 815 with M8 setscrew								
NSH 815T21R30	754.70.11	21	5.09 / 129.3	5.11 / 130.0	1.57 / 40	1.57 / 40	1.18 / 30	753.62.23
NSH 815T21R40	754.70.09	21	5.09 / 129.3	5.11 / 130.0	1.57 / 40	1.57 / 40	1.57 / 40	753.62.43
NSH 815T25R40	754.70.13	25	6.03 / 153.2	6.05 / 153.9	1.57 / 40	1.57 / 40	1.57 / 40	753.62.45

KUS 815

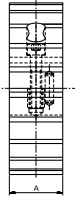
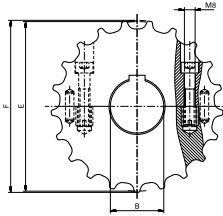

Sprocket Type	Code Number	Number of Teeth	Bore	Pitch Diameter	Outside Diameter	Width (Teeth)	Hub Width	Hub Diameter
			B	E	F	C	A	H
			mm	mm	mm	mm	mm	mm

Split Sprockets And Idlers, Machined - KUS 815

Sprockets, Metric Bores								
KUS815 17-25	753.62.11	17	25	105.5	104.5	40.0	40.0	-
KUS815 17-30	753.62.21	17	30					
KUS815 17-35	753.62.31	17	35					
KUS815 17-40	753.62.41	17	40					
KUS815 19-25	753.62.12	19	25	117.3	116.3			
KUS815 19-30	753.62.22	19	30					
KUS815 19-35	753.62.32	19	35					
KUS815 19-40	753.62.42	19	40					
KUS815 19-50	753.62.62	19	50	129.3	130.0			
KUS815 21-25	753.62.13	21	25					
KUS815 21-30	753.62.23	21	30					
KUS815 21-35	753.62.33	21	35					
KUS815 21-40	753.62.43	21	40	141.2	141.9			
KUS815 21-50	753.62.63	21	50					
KUS815 23-25	753.62.14	23	25					
KUS815 23-30	753.62.24	23	30					
KUS815 23-35	753.62.34	23	35	153.2	153.9			
KUS815 23-40	753.62.44	23	40					
KUS815 23-50	753.62.64	23	50					
KUS815 25-25	753.62.15	25	25					
KUS815 25-30	753.62.25	25	30	165.2	165.9			
KUS815 25-35	753.62.35	25	35					
KUS815 25-40	753.62.45	25	40					
KUS815 25-50	753.62.65	25	50					
KUS815 27-25	753.62.16	27	25	165.2	165.9			
KUS815 27-30	753.62.26	27	30					
KUS815 27-35	753.62.36	27	35					
KUS815 27-40	753.62.46	27	40					
KUS815 27-50	753.62.66	27	50					
Idlers, Metric Bores								
KUS815 17-25	753.61.11	17	25	105.5	104.5	40.0	40.0	-
KUS815 17-30	753.61.21	17	30					
KUS815 17-35	753.61.31	17	35					
KUS815 17-40	753.61.41	17	40					
KUS815 19-25	753.61.12	19	25	117.3	116.3			
KUS815 19-30	753.61.22	19	30					
KUS815 19-35	753.61.32	19	35					
KUS815 19-40	753.61.42	19	40					
KUS815 19-50	753.61.62	19	50	129.3	130.0			
KUS815 21-25	753.61.13	21	25					
KUS815 21-30	753.61.23	21	30					
KUS815 21-35	753.61.33	21	35					
KUS815 21-40	753.61.43	21	40	141.2	141.9			
KUS815 21-50	753.61.63	21	50					
KUS815 23-25	753.61.14	23	25					
KUS815 23-30	753.61.24	23	30					
KUS815 23-35	753.61.34	23	35	141.2	141.9			
KUS815 23-40	753.61.44	23	40					
KUS815 23-50	753.61.64	23	50					

KUS 815

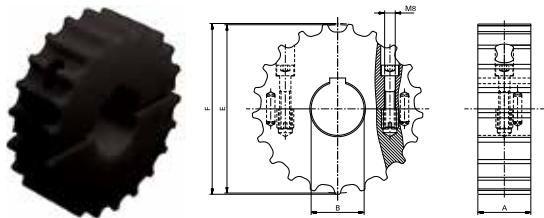

KU 815

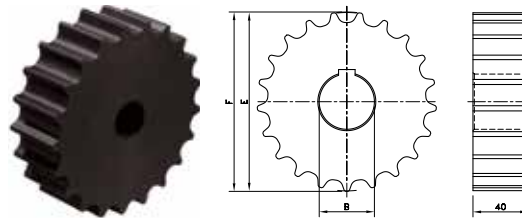

Sprocket Type	Code Number	Number of Teeth	Bore	Pitch Diameter	Outside Diameter	Width (Teeth)	Hub Width	Hub Diameter
			B	E	F	C	A	H
			mm	mm	mm	mm	mm	mm

Idlers, Metric Bores continued

KUS815 25-25	753.61.15	25	25	153.2	153.9	40.0	40.0	-
KUS815 25-30	753.61.25	25	30					
KUS815 25-35	753.61.35	25	35					
KUS815 25-40	753.61.4 5	25	40					
KUS815 25-50	753.61.65	25	50	165.2	165.9	40.0	40.0	-
KUS815 27-25	753.61.16	27	25					
KUS815 27-30	753.61.26	27	30					
KUS815 27-35	753.61.36	27	35					
KUS815 27-40	753.61.46	27	40					
KUS815 27-50	753.61.66	27	50					

For steel chain series: **Rexnord**: 812 (except TAB and mini hinge), 815.
MCC: single hinge straight run, single hinge Magnetflex, 66 ST 75 RM.

Classic Sprockets, Machined - KU 815

Metric Bores

KU815 17-20	753.91.77	17	20*	105.5	104.5	40	-	-
KU815 19-20	753.91.78	19	20*	117.3	116.3			
KU815 21-20	753.91.79	21	20*	129.3	130.0			
KU815 23-20	753.91.80	23	20*	141.2	141.9			
KU815 25-20	753.91.81	25	20*	153.2	153.9			
KU815 27-20	753.91.82	27	20*	165.2	165.9			

*Pre-bore

For steel chain series: **Rexnord**: 812 (except TAB and mini hinge), 815.
MCC: single hinge straight run, single hinge Magnetflex, 66 ST 75 RM.

NSH 820

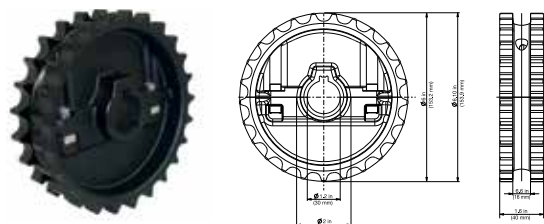

Sprocket Type	Code Number	Number of Teeth	Pitch Diameter	Outside Diameter	Width	Hub Width	Shaft Size	Equivalent to NS 820	Equivalent to NS 831
			in-mm	in-mm	in-mm	in-mm	in-mm		
NSH820/831T25R25	L0820641083	25	6.0 / 153.2	6.1 / 154.2	1.50 / 38	1.6 / 40	0.98 / 25	L0820665361	L0831604202
NSH820/831T25R30	L0820641093	25	6.0 / 153.2	6.1 / 154.2	1.65 / 42	1.6 / 40	1.18 / 30	L0820665371	L0831604212
NSH820/831T25R35	L0820641103	25	6.0 / 153.2	6.1 / 154.2	1.85 / 47	1.6 / 40	1.37 / 35	L0820665381	L0831604222
NSH820/831T25R40	L0820641113	25	6.0 / 153.2	6.1 / 154.2	2.05 / 52	1.6 / 40	1.57 / 40	L0820665391	L0831604232
NSH820/831T25R45	L0820641123	25	6.0 / 153.2	6.1 / 154.2	2.25 / 57	1.6 / 40	1.77 / 45	L0820665401	L0831604242

NS 820

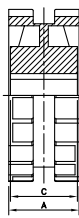
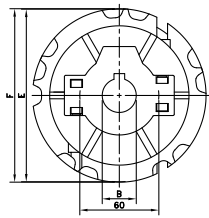

N 820

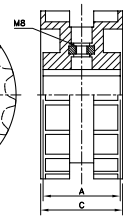
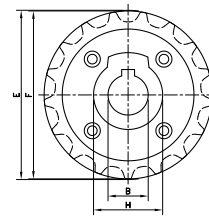

Sprocket Type	Code Number	Number of Teeth	Bore	Pitch Diameter	Outside Diameter	Width (Teeth)	Hub Width	Hub Diameter
			B mm/inch	E mm	F mm	C mm	A mm	H mm
Split Sprockets, Injection Moulded - NS 820								
Metric Bores								
NS820 21-25	L0820664341	21	25	129.3	129.5	52.0	51.0	60
NS820 21-30	L0820664351	21	30	129.3	129.5	52.0	51.0	
NS820 21-35	L0820664361	21	35	129.3	129.5	52.0	51.0	
NS820 21-40	L0820664371	21	40	129.3	129.5	52.0	51.0	
NS820 21-45	L0820664381	21	45	129.3	129.5	52.0	51.0	
NS820 23-25	L0820662531	23	25	141.2	142.0	52.0	51.0	
NS820 23-30	L0820662541	23	30	141.2	142.0	52.0	51.0	
NS820 23-35	L0820662551	23	35	141.2	142.0	52.0	51.0	
NS820 23-40	L0820662561	23	40	141.2	142.0	52.0	51.0	
NS820 23-45	L0820662571	23	45	141.2	142.0	52.0	51.0	
NS820 25-25	L0820665361	25	25	153.2	154.2	54.0	58.5	
NS820 25-30	L0820665371	25	30	153.2	154.2	54.0	58.5	
NS820 25-35	L0820665381	25	35	153.2	154.2	54.0	58.5	
NS820 25-40	L0820665391	25	40	153.2	154.2	54.0	58.5	
NS820 25-45	L0820665401	25	45	153.2	154.2	54.0	58.5	
Inch Bores*								
NS820 21-1	L0820664391	21	1.00"	129.3	129.5	52.0	51.0	60
NS820 21-1¼	L0820664411	21	1.25"	129.3	129.5	52.0	51.0	
NS820 23-1	L0820662741	23	1.00"	141.2	142.0	52.0	51.0	
NS820 23-1¼	L0820662761	23	1.25"	141.2	142.0	52.0	51.0	
NS820 25-1	L0820665611	25	1.00"	153.2	154.2	54.0	58.5	
NS820 25-1¼	L0820665631	25	1.25"	153.2	154.2	54.0	58.5	

For steel chain series (optional): Rexnord: 812 (except TAB and mini hinge), 815.

MCC: single hinge straight run, single hinge Magnetflex.

For plastic chain series: 820, SH; Note: not suitable for 831 and SHD.

* Ask Customer service for minimum order quantity of sprockets with inch bores.

Classic Sprockets, Injection Moulded - N 820								
Metric Bores								
N820 15-25	L0820661451	15	25	93.7	92.2	50.0	50.0	43
N820 15-30	L0820661461	15	30	93.7	92.2	50.0	50.0	43
N820 17-25	L0820661681	17	25	105.5	104.7	51.0	48.0	43
N820 17-30	L0820661691	17	30	105.5	104.7	51.0	48.0	43
N820 19-20	L0820661911	19	20	117.4	117.1	50.0	50.0	60
N820 19-25	L0820661921	19	25	117.4	117.1	50.0	50.0	60
N820 19-30	L0820661931	19	30	117.4	117.1	50.0	50.0	60
N820 19-35	L0820661961	19	35	117.4	117.1	50.0	50.0	60
N820 19-40	L0820661941	19	40	117.4	117.1	50.0	50.0	60

For steel chain series (optional): Rexnord: 812 (except TAB and mini hinge), 815.

MCC: single hinge straight run, single hinge Magnetflex.

For plastic chain series: 820, SH; Note: not suitable for 831 and SHD.

NXT 820

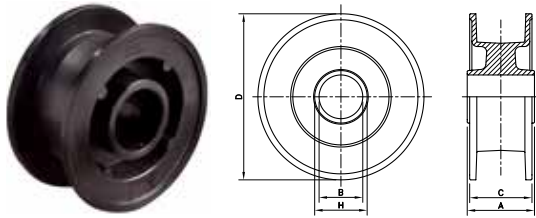

NSXT 820

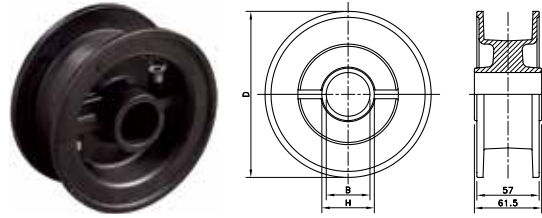

Sprocket Type	Code Number	Number of Teeth	Bore	Pitch Diameter	Outside Diameter	Width (Teeth)	Hub Width	Hub Diameter
			B	E	F	C	A	H
			mm/inch	mm	mm	mm	mm	mm

Classic Idler Drums, Injection Moulded - NXT 820

Metric Bores								
NXT820 15-25	L0820662461	15	25	--	95.5	55.0	92.0	40
NXT820 15-30	L0820662471	15	30	--	95.5	55.0	92.0	40
NXT820 17-25	L0820661701	17	25	--	106.5	53.0	57.0	42
NXT820 17-30	L0820661711	17	30	--	106.5	53.0	57.0	42
NXT820 18-25	L0820661801	18	25	--	113.0	57.0	92.0	40
NXT820 18-30	L0820661811	18	30	--	113.0	57.0	92.0	40
NXT820 19-25	L0820661471	19	25	--	118.0	57.0	57.0	42
NXT820 19-30	L0820661481	19	30	--	118.0	57.0	57.0	42
NXT820 19-40	L0820661491	19	40	--	118.0	57.0	57.0	51
NXT820 21-25	L0820662091	21	25	--	130.0	60.0	61.5	35
NXT820 21-30	L0820662101	21	30	--	130.0	60.0	61.5	40
NXT820 21-35	L0820662121	21	35	--	130.0	60.0	61.5	45
NXT820 21-40	L0820662111	21	40	--	130.0	60.0	61.5	50
NXT820 23-25	L0820661821	23	25	--	142.5	59.5	61.5	35
NXT820 23-30	L0820661831	23	30	--	142.5	59.5	61.5	40
NXT820 23-35	L0820661861	23	35	--	142.5	59.5	61.5	45
NXT820 23-40	L0820661841	23	40	--	142.5	59.5	61.5	50
NXT820 25-25	L0820661721	25	25	--	154.5	59.0	61.5	35
NXT820 25-30	L0820661731	25	30	--	154.5	59.0	61.5	40
NXT820 25-35	L0820661741	25	35	--	154.5	59.0	61.5	45
NXT820 25-40	L0820661751	25	40	--	154.5	59.0	61.5	50
Inch Bores								
NXT820 21-1	L0820619132	21	1.00"	--	130.0	60.0	61.5	35
NXT820 21-1¼	L0820688801	21	1.25"	--	130.0	60.0	61.5	40
NXT820 21-1½	L0820688811	21	1.50"	--	130.0	60.0	61.5	45
NXT820 23-1¼	L0820661891	23	1.25"	--	142.5	59.5	61.5	40
NXT820 23-1½	L0820661881	23	1.50"	--	142.5	59.5	61.5	45
NXT820 25-1	L0820619142	25	1.00"	--	154.5	59.0	61.5	35
NXT820 25-1¼	L0820661761	25	1.25"	--	154.5	59.0	61.5	40
NXT820 25-1½	L0820661771	25	1.50"	--	154.5	59.0	61.5	45

For steel chain series: **Rexnord:** 812 (except TAB and mini hinge), 815, 881 (except TAB), 8811 (except TAB).

MCC: single hinge straight run, single hinge Magnetflex.

For plastic chain series: 879-Bevel, 880-Bevel, 820, 831, SH, SHD, RHM, RHMD, RHMP, RHMDP, SHP.

Split Idler Drums, Injection Moulded - NSXT 820

Metric Bores								
NSXT 820 21-25	L0820665821	21	25	--	130.0	57.0	61.5	40
NSXT 820 21-30	L0820664861	21	30	--	130.0	57.0	61.5	40
NSXT 820 21-35	L0820664881	21	35	--	130.0	57.0	61.5	50
NSXT 820 21-40	L0820665841	21	40	--	130.0	57.0	61.5	50
NSXT 820 23-25	L0820665861	23	25	--	142.5	57.0	61.5	40
NSXT 820 23-30	L0820665881	23	30	--	142.5	57.0	61.5	40
NSXT 820 23-35	L0820665901	23	35	--	142.5	57.0	61.5	50
NSXT 820 23-40	L0820665921	23	40	--	142.5	57.0	61.5	50
NSXT 820 25-25	L0820665591N	25	25	--	154.5	57.0	61.5	35
NSXT 820 25-30	L0820665941N	25	30	--	154.5	57.0	61.5	40
NSXT 820 25-35	L0820665961N	25	35	--	154.5	57.0	61.5	45
NSXT 820 25-40	L0820664901N	25	40	--	154.5	57.0	61.5	50
NSXT 820 25-45	L0820697961N	25	45	--	154.5	57.0	61.5	50