

# Part. S0874

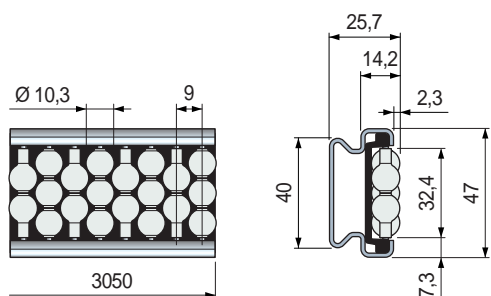

## ■ Pearl roller side guide



Pearl material	Code	Weight kg
Polyethylene PE (Aubergine)	<b>649353</b>	1,55
Polyethylene PE (white)	<b>649363</b>	

- Material: metal profile in Austenitic stainless steel, rollers module in acetal POM (black), roller pins in stainless steel.
- Standard packaging: strands 3,05 metres.
- Packaging: 2 strands.

The roller side guides can be supplied with separated components.

### Metal profile

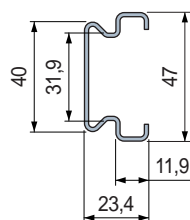

Length mm	Code
3050	<b>649413</b>

### Pearls module

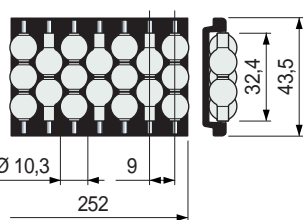

Materiale Perle™	Code
Polyethylene PE (Aubergine)	<b>644653</b>
Polyethylene PE (white)	<b>644633</b>

- Material: Austenitic stainless steel.
- Weight: 1,21 Kg/m.
- Packaging: 1 strand.

# Part. S0794



## ■ Side Clamp

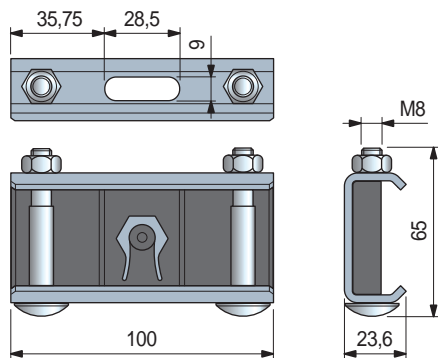

Metal Body	Code	Weight kg
Ferritic Stainless Steel	<b>625363</b>	0,28

- Plastic Insert Material: POM (Black).
- Hardware: Stainless Steel.
- Packaging: 12 pieces.

● Best Seller

● Standard

● On request: minimum quantity may apply. Consult our Customer Service for availability.

Item code for order = Part. + Code

## • Characteristics Part. S0874

- Self supporting structure.
- Metal Profile in Austenitic stainless steel.
- Quick and easy installation by standard bolts.
- Can be used straight running and sidelifing.

## • Assembly Part. S0874

M10 hex head bolt

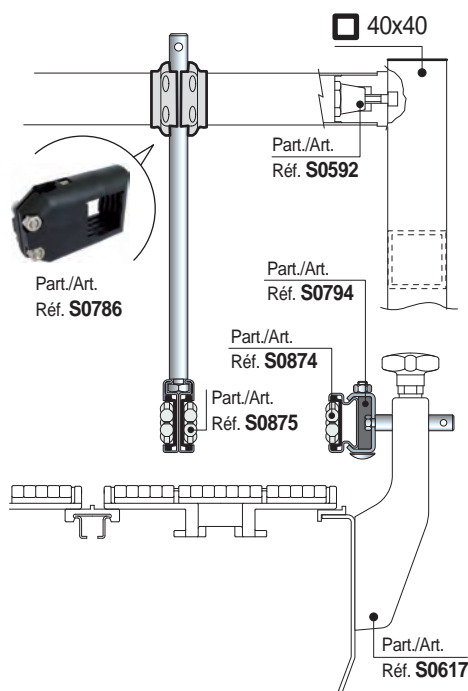
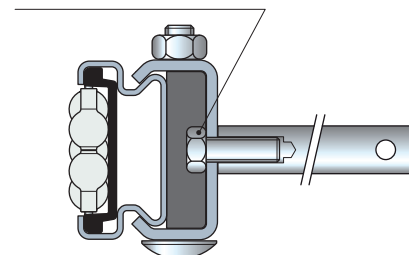

## • Min. curvature radius Part. S0874

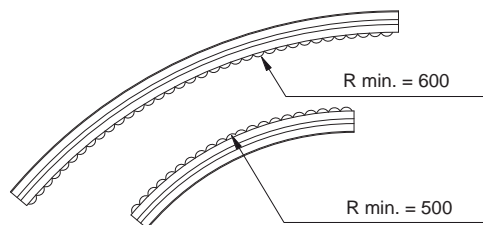

## • Installation - side Usage

