

Part. S0870

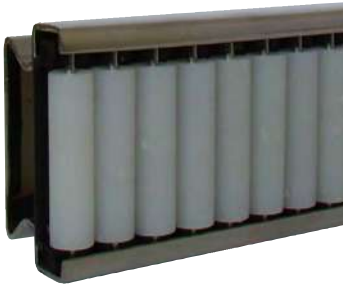

Roller side guides with cylinder rollers

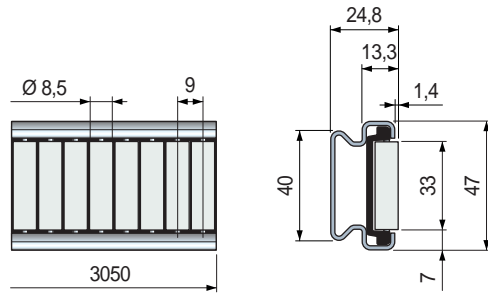

Cylinder rollers

	Code	Weight kg
Polyethylene PE (white)	649313	1,60

- Material: metal profile in Austenitic stainless steel, rollers module in acetal POM (black), roller pins in stainless steel.
- Standard packaging: strands 3,05 metres.
- Packaging: 2 strands.

The roller side guides can be supplied with separated components.

Metal profile

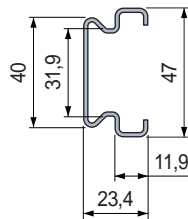

Cylinder roller module

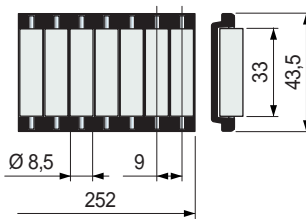

Length mm	Code	Cylinder rollers material	Code
3050	649413	Polyethylene PE (white)	644613

- Material: Austenitic stainless steel.
- Weight: 1,21 Kg/m.
- Packaging: 1 strand.

Part. S0794

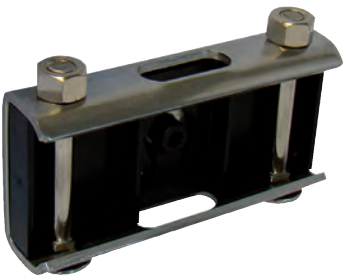

Side Clamp

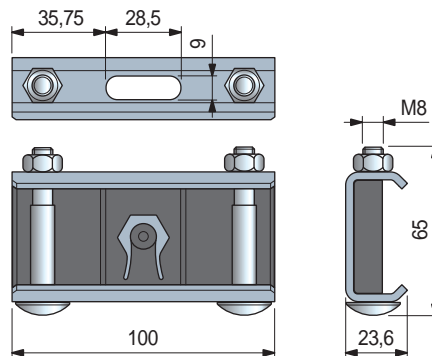

Metal Body	Code	Weight kg
Ferritic Stainless Steel	625363	0,28

- Plastic Insert Material: POM (Black).
- Hardware: Stainless Steel.
- Packaging: 12 pieces.

Characteristics Part. S0870

- Self supporting structure.
- Metal Profile in Austenitic stainless steel.
- Quick and easy installation by standard bolts.
- Can be used straight running and sideflexing.

Assembly Part. S0870

M10 hex head bolt

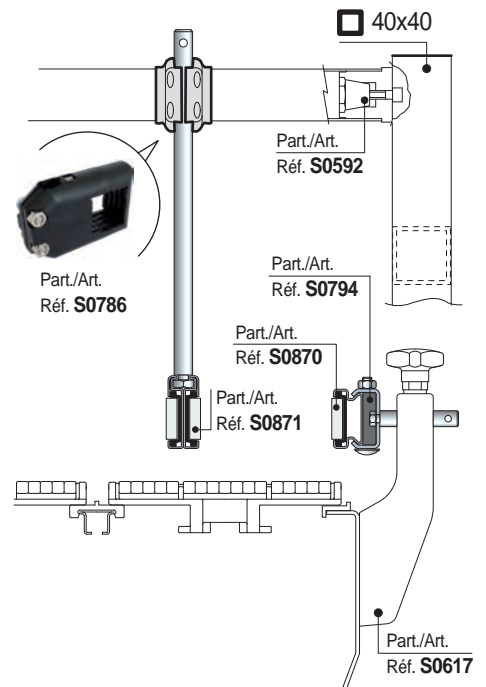
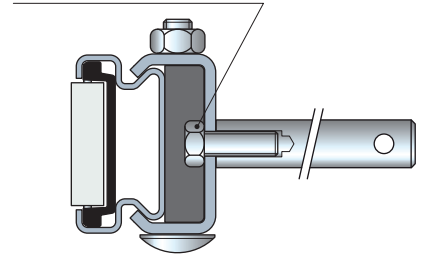

Min. curvature radius Part. S0870

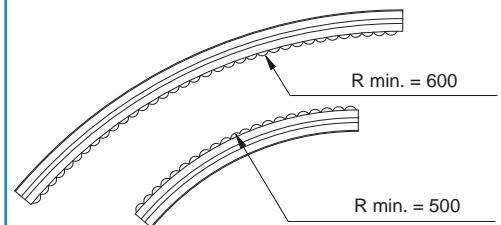

Installation - side Usage

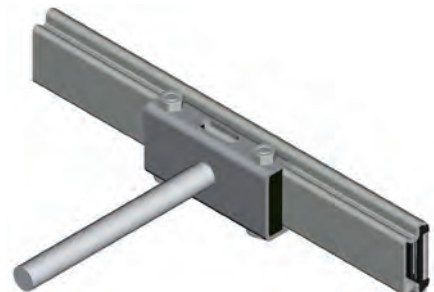

● Best Seller

● Standard

● On request: minimum quantity may apply. Consult our Customer Service for availability.

Item code for order = Part. + Code