

Part. S0868

Roller side guides with cylinder rollers

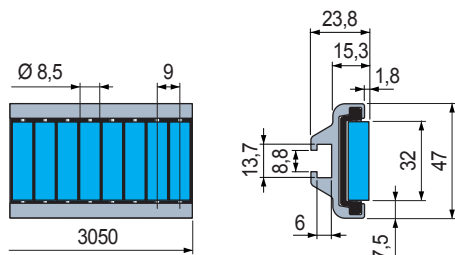

Cylinder rollers material	Code	Weight kg
SEBS rubber (Blue)	647573	1,20

- Material: metal profile in anodized aluminium, rollers module in acetal POM (black), roller pins in stainless steel.
- Standard packaging: strands 3,05 metres.
- Packaging: 2 strands.

The roller side guides can be supplied with separated components.

Metal profile

Cylinder roller module

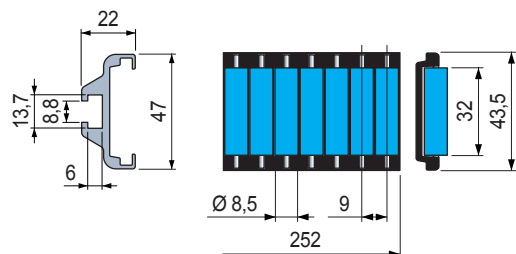

Length mm	Code	Cylinder rollers material	Code
3050	607933	SEBS rubber (Blue)	646523
6100	607943		

- Material: anodized aluminium.
- Weight: 0,85 Kg/m.
- Packaging: 1 strand.

- Characteristics Part. S0868
 - Self supporting structure.
 - Anodized aluminium profile.
 - Quick and easy installation by standard bolts.
 - Can be used straight running and sideflexing.

- Assembly Part. S0868

M8 hex head bolt

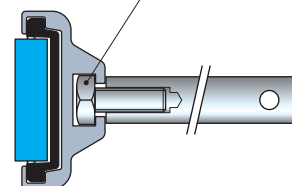

- Accessories
Part. S0369 - Connecting bar

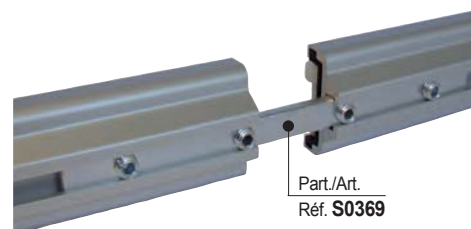

For assembly insert the guides and tighten the set screw.

- Min. curvature radius Part. S0868

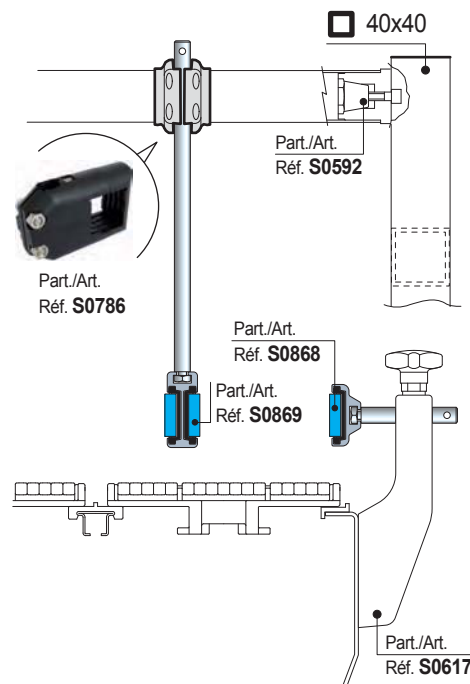
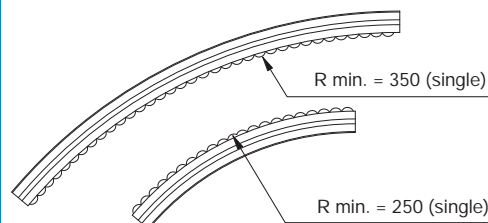

● Best Seller

● Standard

● On request: minimum quantity may apply. Consult our Customer Service for availability.

Item code for order = Part. + Code

Part. S0868

Roller side guides with cylinder rollers

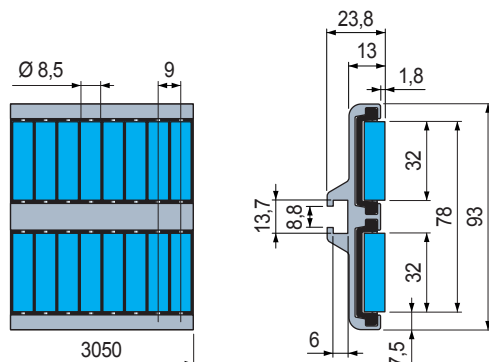

Cylinder rollers material	Code	Weight kg
SEBS rubber (blue)	647593	2,00

- Material: metal profile in anodized aluminium, rollers module in acetal POM (black), roller pins in stainless steel.
- Standard packaging: strands 3,05 metres.
- Packaging: 2 strands.

The roller side guides can be supplied with separated components.

Metal profile

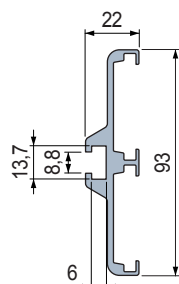

Cylinder roller module

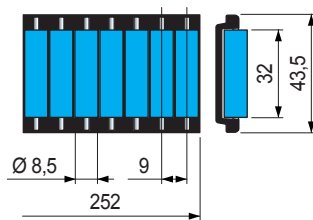

Length mm	Code	Cylinder rollers material	Code
3050	607953	SEBS rubber (blue)	646523
6100	607963		

- Material: anodized aluminium.
- Weight: 1,36 Kg/m.
- Packaging: 1 strand.

● Best Seller

● Standard

● On request: minimum quantity may apply. Consult our Customer Service for availability.

Item code for order = Part. + Code

- **Characteristics** Part. S0868
 - Self supporting structure.
 - Anodized aluminium profile.
 - Quick and easy installation by standard bolts.
 - Can be used straight running and sideflexing.

Assembly Part. S0868

M8 hex head bolt

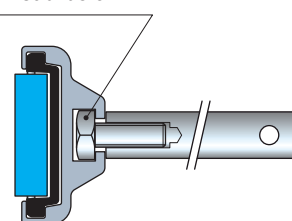

Accessories

Part. S0369 - Connecting bar

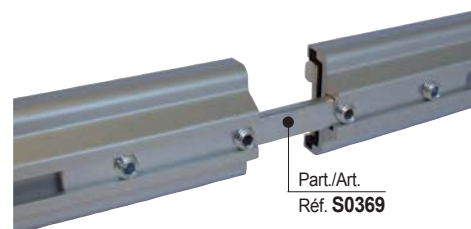

For assembly insert the guides and tighten the set screw.

Min. curvature radius Part. S0868

