

## Part. S0694

### ■ Guide-rail clamp

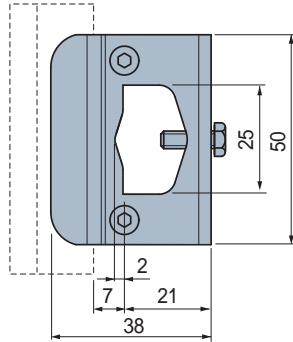

With two fixing screws

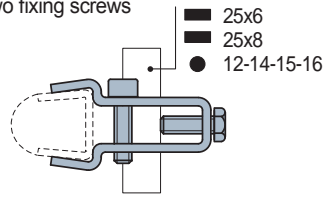

Code	Weight kg
689222	0,10

- Material: clamp and bolt in austenitic stainless steel.
- Packaging: 16 pieces.

### • Assembly of Part. S0694

Fixing on plates

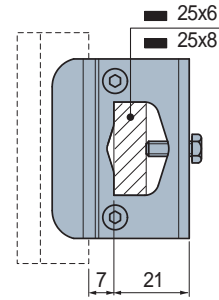

Fixing on rods

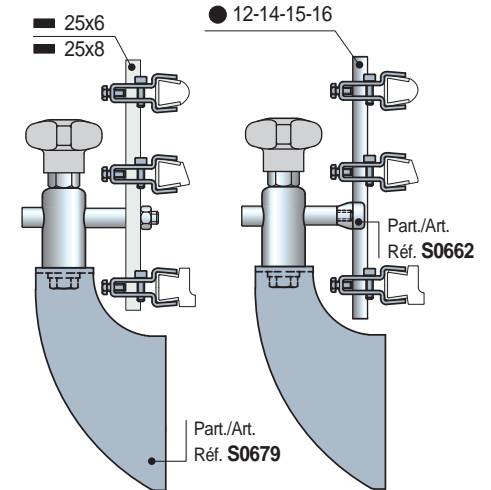
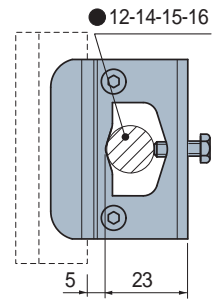

### • Pin dimensions for Part. S0217

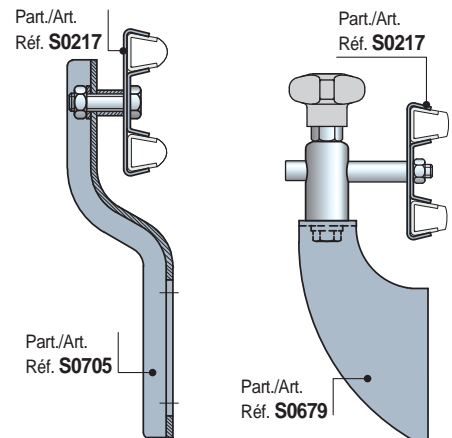
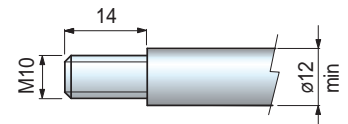

### • Swivel pin connection of Part. S0740 - S0740P

Use for conveyors with (format change). They allow an easy regulation of product-guides on corner tracks.

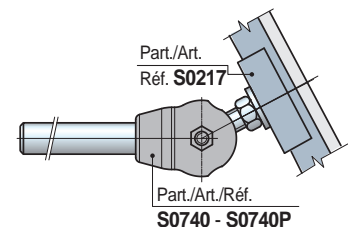

## Part. S0217

### ■ Guide-rail clamp (double)

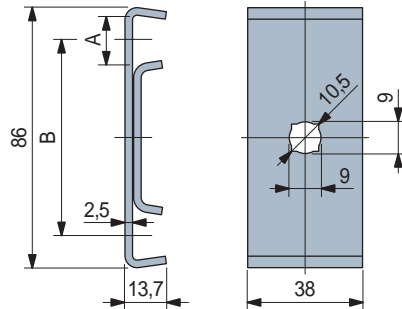

Use	A mm	B mm	Code	Weight kg
For guides with S = 1,5	16	64,5	60141	0,14
For guides with S = 2	17	63,5	695131	

- Material: austenitic stainless steel.
- Packaging: 50 pieces.
- Accessories: swivel pin connection Part. S0740 - S0740P.

● Best Seller

● Standard

● On request: minimum quantity may apply. Consult our Customer Service for availability.

Item code for order = Part. + Code