

• TableTop® chains / PlateTop chains

Chain width 82,5 mm (K 325)

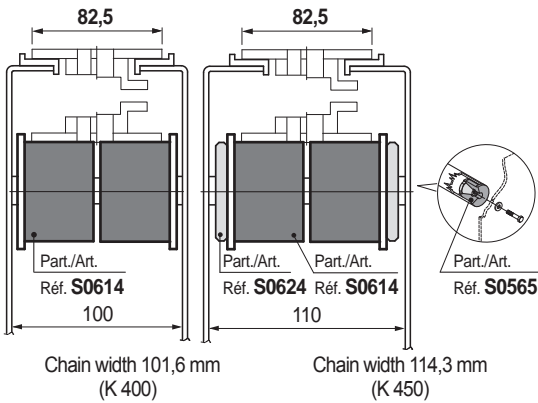

Chain width 101,6 mm (K 400)

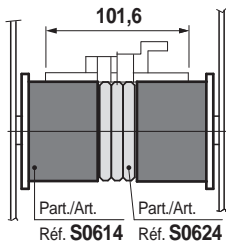

Chain width 114,3 mm (K 450)

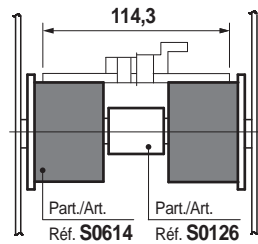

Chain width 82,5 mm (K 325) / Pitch 85 mm

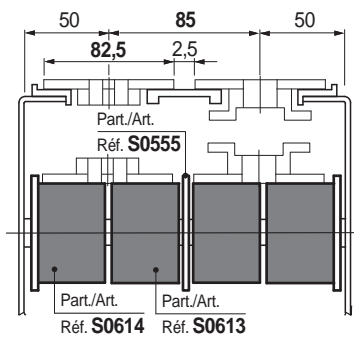

Chain width 82,5 mm (K 325) / Pitch 83,5 mm

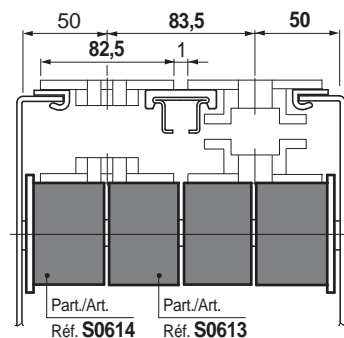

Chain width 114,3 mm (K 450) / Pitch 120 mm

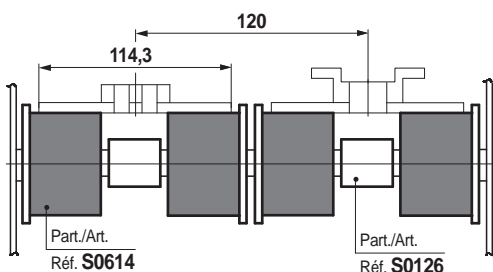

■ Roller (with rubber surface)

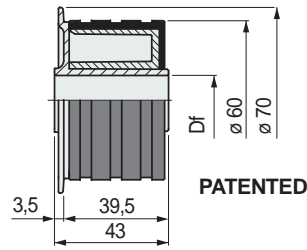

Shaft dia.		Bore dia.		Code
mm	inch	Df	mm	
12,7	1/2	13,2	632482	
15	-	15,5	615382	
16	5/8	16,5	615392	
18	-	18,5	615402	
19,05	3/4	19,5	635152	
20	-	20,5	615412	

- Characteristics: completely closed design. Rubber surface for less noise even in high speed conveyors. Hub in acetal for low friction.
- Material: roller in acetal POM (white). Surface in thermoplastic rubber (grey). 70 shore hardness.
- Packaging: 100 pieces.

Part. S0614



Dia. 60 mm

■ Roller (with rubber surface)

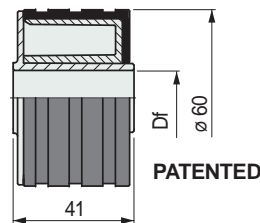

Shaft dia.		Bore dia.		Code
mm	inch	Df	mm	
12,7	1/2	13,2	632472	
15	-	15,5	615342	
16	5/8	16,5	615352	
18	-	18,5	615362	
19,05	3/4	19,5	635142	
20	-	20,5	615372	

- Characteristics: completely closed design. Rubber surface for less noise even in high speed conveyors. Hub in acetal for low friction.
- Material: roller in acetal POM (white). Surface in thermoplastic rubber (grey). 70 shore hardness.
- Packaging: 100 pieces.

Part. S0613



Dia. 60 mm

● Best Seller

● Standard

● On request: minimum quantity may apply. Consult our Customer Service for availability.

Item code for order = Part. + Code