

Guide - Rail Clamps for

- Part. S0223
- Part. S0317
- Part. S0219
- Part. S0273
- Part. S0393
- Part. S0596
- Part. S0308
- Part. S0715
- Part. S0765
- Part. S0767
- Part. S0768
- Part. S0769
- Part. S0770

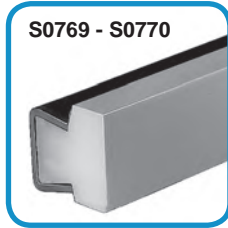

Part. S0210P

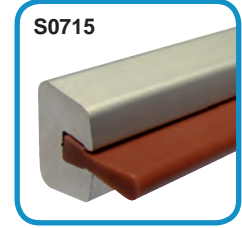
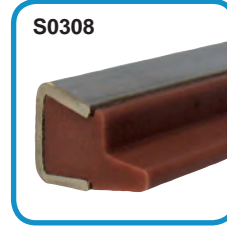
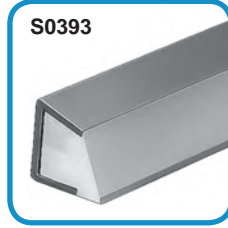
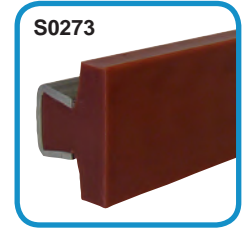
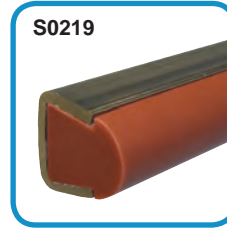
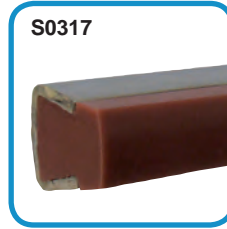

Guide rail clamp

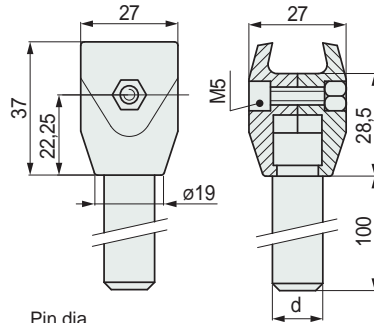

Pin dia. d mm	Code	Weight kg
12	6203910	0,12
14	6185510	0,15

- Material: guide rail clamps in reinforced polyamide PA FV (black). Pin in austenitic stainless steel. Bolt in austenitic stainless steel. Nut in nickel plated brass.
- Packaging: 50 pieces.

Guide rail clamp

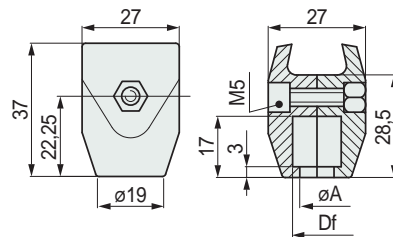

Use	Bore dia. Df mm	Ø A mm	Code	Weight kg
for pins dia. 12	12	10	600372	0,02
for pins dia. 14	13,5	11,5	59941	

- Material: guide rail clamps in reinforced polyamide PA FV (black). Bolt in austenitic stainless steel. Nut in nickel plated brass.
- Packaging: 100 pieces.
- Accessories: swivel pin connection Part. S0739 - S0739P.

- **Swivel pin connection** Part. S0739 - S0739P
Use for conveyors with (format change). They allow an easy regulation of product-guides on corner tracks.

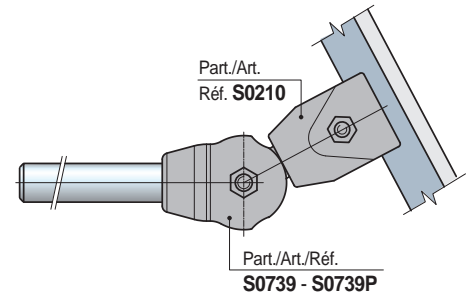

Pin dimensions for Part. S0210

Pin dia. 12 mm

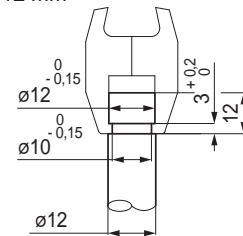

Pin dia. 14 mm

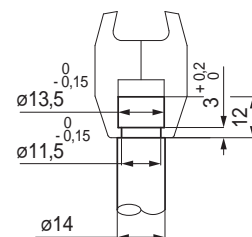

Part. S0210



● **Best Seller**

● **Standard**

● **On request:** minimum quantity may apply. Consult our Customer Service for availability.

Item code for order = Part. + Code