

Part. S0073

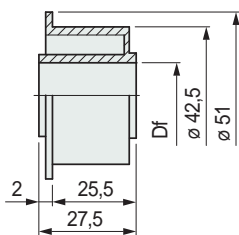

Dia. 42,5 mm

Roller



Shaft dia. mm	Bore dia. Df mm	Code
12	12,5	50660
16	16,5	62946
18	18,5	50670
20	20,5	50680

- Material: polyethylene PE (black).
- Packaging: 100 pieces.

Part. S0126



Separator

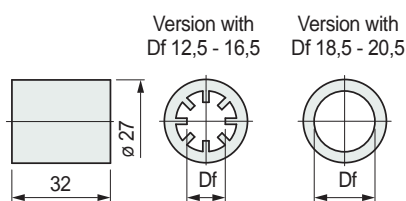

Shaft dia. mm	Bore dia. Df mm	Code
12	12,5	65396
16	16,5	65406
18	18,5	65416
20	20,5	62520

- Material: polyethylene PE (black).
- Packaging: 100 pieces.

Part. S0125



Dia. 42,5 mm

Double roller L55

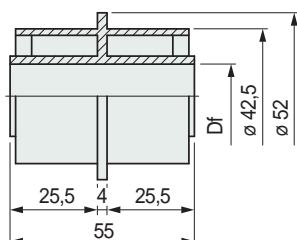

Shaft dia. mm	Bore dia. Df mm	Code
12	12,5	62956
16	16,5	62966
18	18,5	62976
20	20,5	62510

- Material: polyethylene PE (black).
- Packaging: 100 pieces.

TableTop® chains / PlateTop chains

Chain width 82,5 mm (K 325)

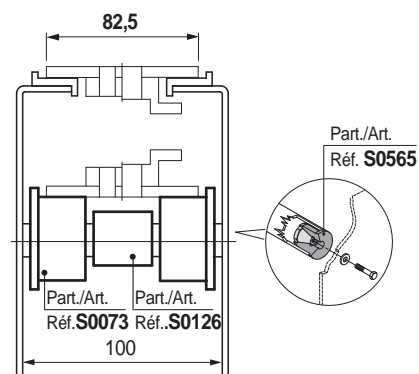

Chain width 114,3 mm (K 450)

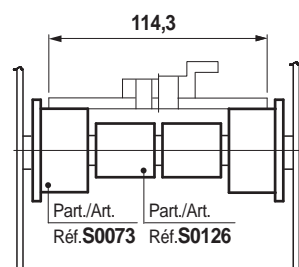

Chain width 82,5 mm (K 325) / Pitch 88 mm

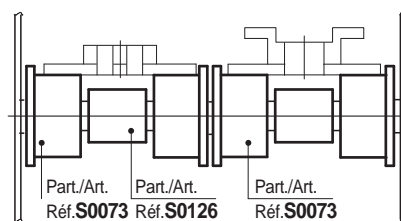
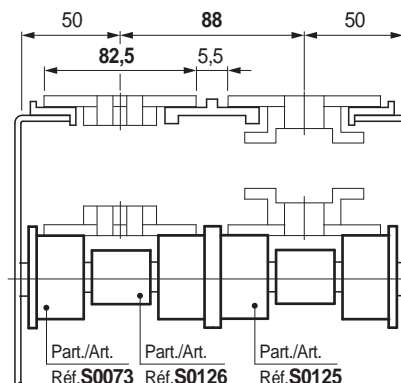

Chain width 114,3 mm (K 450) / Pitch 120 mm

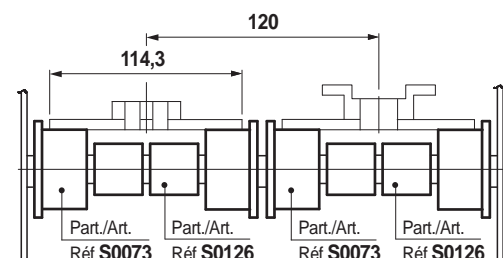

● Best Seller

● Standard

● On request: minimum quantity may apply. Consult our Customer Service for availability.

Item code for order = Part. + Code