

Straight Run Single Hinge

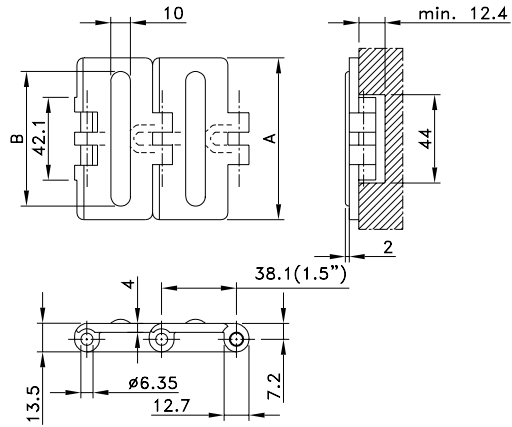

Chain Type	Code Number	Plate Width		Weight	Working Load (max.)	Backflex Radius (min)	Plate Thickness
		A					
		mm	inch	kg/m	N (21°C)	mm	mm
LF-Acetal							
HFP 820-K325	L0820688461	82.5	3.25	0.83	1230	40	4.0
HFP 820-K400	L0820610152	101.6	4.00	0.95			
HFP 820-K450	L0820606852	114.3	4.50	1.03			
HFP 820-K600	L0820610172	152.4	6.00	1.25			

Standard length: 3.048 m - 10 feet (80 links).

The width (B) of the rubber varies per chain type:

65.0, 84, 96 and 135.0 for respectively HFP 820-K325, HFP 820-K400, HFP 820-K450 and HFP 820-K600.

Minimum order quantity 30.48 m – 100 feet.

NS 820

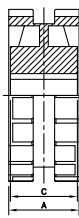
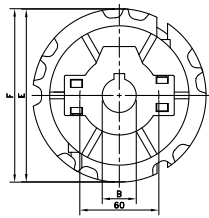

N 820

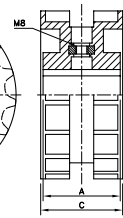
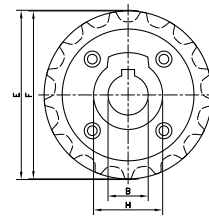

Sprocket Type	Code Number	Number of Teeth	Bore	Pitch Diameter	Outside Diameter	Width (Teeth)	Hub Width	Hub Diameter
			B mm/inch	E mm	F mm	C mm	A mm	H mm
Split Sprockets, Injection Moulded - NS 820								
Metric Bores								
NS820 21-25	L0820664341	21	25	129.3	129.5	52.0	51.0	60
NS820 21-30	L0820664351	21	30	129.3	129.5	52.0	51.0	
NS820 21-35	L0820664361	21	35	129.3	129.5	52.0	51.0	
NS820 21-40	L0820664371	21	40	129.3	129.5	52.0	51.0	
NS820 21-45	L0820664381	21	45	129.3	129.5	52.0	51.0	
NS820 23-25	L0820662531	23	25	141.2	142.0	52.0	51.0	
NS820 23-30	L0820662541	23	30	141.2	142.0	52.0	51.0	
NS820 23-35	L0820662551	23	35	141.2	142.0	52.0	51.0	
NS820 23-40	L0820662561	23	40	141.2	142.0	52.0	51.0	
NS820 23-45	L0820662571	23	45	141.2	142.0	52.0	51.0	
NS820 25-25	L0820665361	25	25	153.2	154.2	54.0	58.5	
NS820 25-30	L0820665371	25	30	153.2	154.2	54.0	58.5	
NS820 25-35	L0820665381	25	35	153.2	154.2	54.0	58.5	
NS820 25-40	L0820665391	25	40	153.2	154.2	54.0	58.5	
NS820 25-45	L0820665401	25	45	153.2	154.2	54.0	58.5	
Inch Bores*								
NS820 21-1	L0820664391	21	1.00"	129.3	129.5	52.0	51.0	60
NS820 21-1¼	L0820664411	21	1.25"	129.3	129.5	52.0	51.0	
NS820 23-1	L0820662741	23	1.00"	141.2	142.0	52.0	51.0	
NS820 23-1¼	L0820662761	23	1.25"	141.2	142.0	52.0	51.0	
NS820 25-1	L0820665611	25	1.00"	153.2	154.2	54.0	58.5	
NS820 25-1¼	L0820665631	25	1.25"	153.2	154.2	54.0	58.5	

For steel chain series (optional): Rexnord: 812 (except TAB and mini hinge), 815.

MCC: single hinge straight run, single hinge Magnetflex.

For plastic chain series: 820, SH; Note: not suitable for 831 and SHD.

* Ask Customer service for minimum order quantity of sprockets with inch bores.

Classic Sprockets, Injection Moulded - N 820								
Metric Bores								
N820 15-25	L0820661451	15	25	93.7	92.2	50.0	50.0	43
N820 15-30	L0820661461	15	30	93.7	92.2	50.0	50.0	43
N820 17-25	L0820661681	17	25	105.5	104.7	51.0	48.0	43
N820 17-30	L0820661691	17	30	105.5	104.7	51.0	48.0	43
N820 19-20	L0820661911	19	20	117.4	117.1	50.0	50.0	60
N820 19-25	L0820661921	19	25	117.4	117.1	50.0	50.0	60
N820 19-30	L0820661931	19	30	117.4	117.1	50.0	50.0	60
N820 19-35	L0820661961	19	35	117.4	117.1	50.0	50.0	60
N820 19-40	L0820661941	19	40	117.4	117.1	50.0	50.0	60

For steel chain series (optional): Rexnord: 812 (except TAB and mini hinge), 815.

MCC: single hinge straight run, single hinge Magnetflex.

For plastic chain series: 820, SH; Note: not suitable for 831 and SHD.

NXT 820

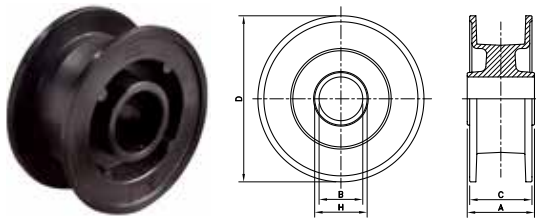

NSXT 820

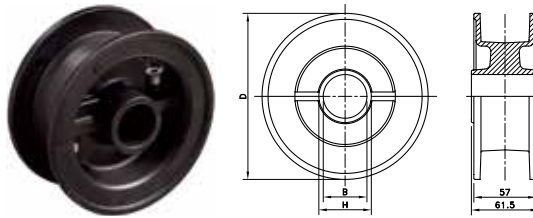

Sprocket Type	Code Number	Number of Teeth	Bore	Pitch Diameter	Outside Diameter	Width (Teeth)	Hub Width	Hub Diameter
			B	E	F	C	A	H
			mm/inch	mm	mm	mm	mm	mm

Classic Idler Drums, Injection Moulded - NXT 820

Metric Bores								
NXT820 15-25	L0820662461	15	25	--	95.5	55.0	92.0	40
NXT820 15-30	L0820662471	15	30	--	95.5	55.0	92.0	40
NXT820 17-25	L0820661701	17	25	--	106.5	53.0	57.0	42
NXT820 17-30	L0820661711	17	30	--	106.5	53.0	57.0	42
NXT820 18-25	L0820661801	18	25	--	113.0	57.0	92.0	40
NXT820 18-30	L0820661811	18	30	--	113.0	57.0	92.0	40
NXT820 19-25	L0820661471	19	25	--	118.0	57.0	57.0	42
NXT820 19-30	L0820661481	19	30	--	118.0	57.0	57.0	42
NXT820 19-40	L0820661491	19	40	--	118.0	57.0	57.0	51
NXT820 21-25	L0820662091	21	25	--	130.0	60.0	61.5	35
NXT820 21-30	L0820662101	21	30	--	130.0	60.0	61.5	40
NXT820 21-35	L0820662121	21	35	--	130.0	60.0	61.5	45
NXT820 21-40	L0820662111	21	40	--	130.0	60.0	61.5	50
NXT820 23-25	L0820661821	23	25	--	142.5	59.5	61.5	35
NXT820 23-30	L0820661831	23	30	--	142.5	59.5	61.5	40
NXT820 23-35	L0820661861	23	35	--	142.5	59.5	61.5	45
NXT820 23-40	L0820661841	23	40	--	142.5	59.5	61.5	50
NXT820 25-25	L0820661721	25	25	--	154.5	59.0	61.5	35
NXT820 25-30	L0820661731	25	30	--	154.5	59.0	61.5	40
NXT820 25-35	L0820661741	25	35	--	154.5	59.0	61.5	45
NXT820 25-40	L0820661751	25	40	--	154.5	59.0	61.5	50
Inch Bores								
NXT820 21-1	L0820619132	21	1.00"	--	130.0	60.0	61.5	35
NXT820 21-1¼	L0820688801	21	1.25"	--	130.0	60.0	61.5	40
NXT820 21-1½	L0820688811	21	1.50"	--	130.0	60.0	61.5	45
NXT820 23-1¼	L0820661891	23	1.25"	--	142.5	59.5	61.5	40
NXT820 23-1½	L0820661881	23	1.50"	--	142.5	59.5	61.5	45
NXT820 25-1	L0820619142	25	1.00"	--	154.5	59.0	61.5	35
NXT820 25-1¼	L0820661761	25	1.25"	--	154.5	59.0	61.5	40
NXT820 25-1½	L0820661771	25	1.50"	--	154.5	59.0	61.5	45

For steel chain series: Rexnord: 812 (except TAB and mini hinge), 815, 881 (except TAB), 8811 (except TAB).

MCC: single hinge straight run, single hinge Magnetflex.

For plastic chain series: 879-Bevel, 880-Bevel, 820, 831, SH, SHD, RHM, RHMD,RHMP, RHMDP, SHP.

Split Idler Drums, Injection Moulded - NSXT 820

Metric Bores								
NSXT 820 21-25	L0820665821	21	25	--	130.0	57.0	61.5	40
NSXT 820 21-30	L0820664861	21	30	--	130.0	57.0	61.5	40
NSXT 820 21-35	L0820664881	21	35	--	130.0	57.0	61.5	50
NSXT 820 21-40	L0820665841	21	40	--	130.0	57.0	61.5	50
NSXT 820 23-25	L0820665861	23	25	--	142.5	57.0	61.5	40
NSXT 820 23-30	L0820665881	23	30	--	142.5	57.0	61.5	40
NSXT 820 23-35	L0820665901	23	35	--	142.5	57.0	61.5	50
NSXT 820 23-40	L0820665921	23	40	--	142.5	57.0	61.5	50
NSXT 820 25-25	L0820665591N	25	25	--	154.5	57.0	61.5	35
NSXT 820 25-30	L0820665941N	25	30	--	154.5	57.0	61.5	40
NSXT 820 25-35	L0820665961N	25	35	--	154.5	57.0	61.5	45
NSXT 820 25-40	L0820664901N	25	40	--	154.5	57.0	61.5	50
NSXT 820 25-45	L0820697961N	25	45	--	154.5	57.0	61.5	50

NS 831

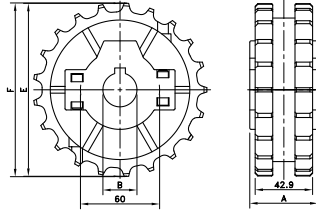

NSH 820/831

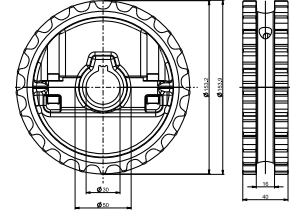

Sprocket Type	Code Number	Number of Teeth	Bore	Pitch Diameter	Outside Diameter	Width (Teeth)	Hub Width	Hub Diameter
			B	E	F	C	A	
			mm/inch	mm	mm	mm	mm	mm

Split Sprockets, Injection Moulded - NS 831

Metric Bores								
NS831 21-25	L0831604102	21	25	129.3	129.5	42.9	51.0	60
NS831 21-30	L0831604112	21	30					
NS831 21-35	L0831604122	21	35					
NS831 21-40	L0831604132	21	40					
NS831 21-45	L0831604142	21	45					
NS831 23-25	L0831604152	23	25	141.2	142.0	42.9	51.0	60
NS831 23-30	L0831604162	23	30					
NS831 23-35	L0831604172	23	35					
NS831 23-40	L0831604182	23	40					
NS831 23-45	L0831604192	23	45					
NS831 25-25	L0831604202	25	25	153.2	154.2	42.9	58.5	60
NS831 25-30	L0831604212	25	30					
NS831 25-35	L0831604222	25	35					
NS831 25-40	L0831604232	25	40					
NS831 25-45	L0831604242	25	45					
Inch Bores								
NS831 21-1	L0831604252	21	1.000"	129.26	129.5	42.9	51.0	60
NS831 25-1	L0831604312	25	1.000"	153.21	154.2	42.9	58.5	

For plastic chain series: 820, 831, SH, SHD

* Ask Customer service for minimum order quantity of sprockets with inch bores.

Split Sprockets, Injection Moulded - NSH 820/831

Metric Bores								
NSH820/831 25-25	L0820641083	25	25	153,2	154,2	42,9	40	60
NSH820/831 25-30	L0820641093	25	30					
NSH820/831 25-35	L0820641103	25	35					
NSH820/831 25-40	L0820641113	25	40					
NSH820/831 25-45	L0820641123	25	45					

For plastic chain series: 820, 831, SH, SHD.

SS SH

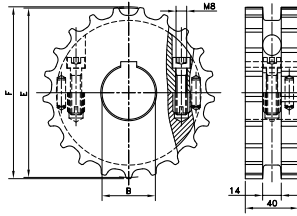

Sprocket Type	Code Number	Number of Teeth	Bore	Pitch Diameter	Outside Diameter	Width (Teeth)	Hub Width	Hub Diameter
			B	E	F	C	A	H
			mm/inch	mm	mm	mm	mm	mm

Split Sprockets, Machined - SS SH

Metric Bores								
SS SH 17-25	754.62.11	17	25	105.5	104.5	40	40	--
SS SH 17-30	754.62.21	17	30					
SS SH 17-35	754.62.31	17	35					
SS SH 17-40	754.62.41	17	40					
SS SH 19-25	754.62.12	19	25	117.3	116.3			
SS SH 19-30	754.62.22	19	30					
SS SH 19-35	754.62.32	19	35					
SS SH 19-40	754.62.42	19	40					
SS SH 19-50	754.62.62	19	50	129.3	130.0			
SS SH 21-25	754.62.13	21	25					
SS SH 21-30	754.62.23	21	30					
SS SH 21-35	754.62.33	21	35					
SS SH 21-40	754.62.43	21	40	141.2	141.9			
SS SH 21-50	754.62.63	21	50					
SS SH 23-25	754.62.14	23	25					
SS SH 23-30	754.62.24	23	30					
SS SH 23-35	754.62.34	23	35	153.2	153.9			
SS SH 23-40	754.62.44	23	40					
SS SH 23-50	754.62.64	23	50					
SS SH 25-25	754.62.15	25	25					
SS SH 25-30	754.62.25	25	30	165.2	165.9			
SS SH 25-35	754.62.35	25	35					
SS SH 25-40	754.62.45	25	40					
SS SH 25-50	754.62.65	25	50					
SS SH 27-25	754.62.16	27	25	129.3	130.0			
SS SH 27-30	754.62.26	27	30					
SS SH 27-35	754.62.36	27	35					
SS SH 27-40	754.62.46	27	40					
SS SH 27-50	754.62.66	27	50	153.2	153.9			
SS SH 21-1	754.66.12	21	1.000"					
SS SH 21-1 ³ / ₁₆	754.66.22	21	1.188"					
SS SH 21-1 ¹ / ₄	754.66.32	21	1.250"					
SS SH 21-1 ⁷ / ₁₆	754.66.42	21	1.438"	129.3	130.0			
SS SH 21-1 ¹ / ₂	754.66.52	21	1.500"					
SS SH 25-1	754.66.15	25	1.000"					
SS SH 25-1 ³ / ₁₆	754.66.25	25	1.188"					
SS SH 25-1 ¹ / ₄	754.66.35	25	1.250"	153.2	153.9			
SS SH 25-1 ⁷ / ₁₆	754.66.45	25	1.438"					
SS SH 25-1 ¹ / ₂	754.66.55	25	1.500"					

For plastic chain series: 820, 831, SH, SHD.