

Straight Run Double Hinge LBP

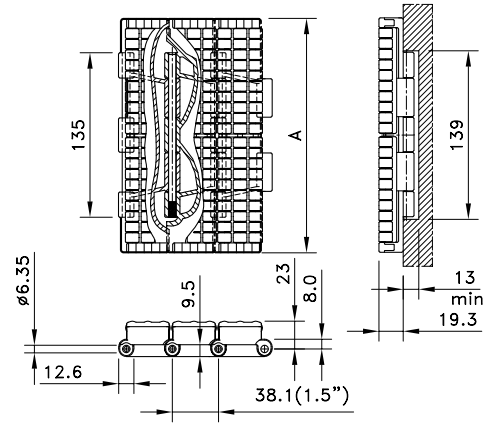

Chain Type	Code Number	Plate Width		Weight	Working Load (max.)	Backflex Radius (min)	Plate Thickness
		A	A				
		mm	inch	kg/m	N (21°C)	mm	mm
XLA-Acetal							
SWH 750 LBP	752.82.09	190.5	7.50	5.30	2680	300	4.8
SWH 1000 LBP	752.82.11	254.0	10.00	6.60			
SWH 1200 LBP	752.82.10	304.8	12.00	7.85			

Standard length: 1.524 m - 5 feet (40 links).

NS/NSX 821

N/NX 800

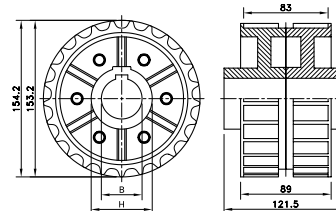
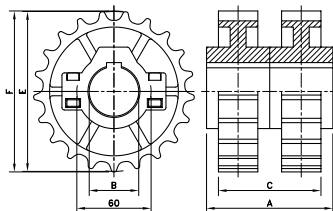

Sprocket Type	Code Number	Number of Teeth	Bore	Pitch Diameter	Outside Diameter	Width (Teeth)	Hub Width	Hub Diameter
			B	E	F	C	A	H
			mm/inch	mm	mm	mm	mm	mm

Split Sprockets And Idlers, Injection Moulded - NS/NSX 821

Sprockets, Metric Bores

NS821 21-35	L0821665261	21	35	129.2	129.5	82.0	103.0	60
NS821 21-40	L0821665121	21	40					
NS821 21-45	L0821665271	21	45					
NS821 23-30	L0821648082	23	30	141.2	142.0			
NS821 23-35	L0821663111	23	35					
NS821 23-40	L0821663121	23	40					
NS821 23-45	L0821663131	23	45	153.2	154.2	82.0	117.0	
NS821 25-30	L0821600482	25	30					
NS821 25-35	L0821665671	25	35					
NS821 25-40	L0821665681	25	40					
NS821 25-45	L0821665691	25	45					

Idlers, Metric Bores

NSX821 21-30	L0821665001	21	30	129.2	129.5	82.0	103.0	60
NSX821 21-35	L0821665031	21	35					
NSX821 21-40	L0821665061	21	40					
NSX821 23-30	L0821663011	23	30	141.2	142.0			
NSX821 23-35	L0821663041	23	35					
NSX821 23-40	L0821663071	23	40					
NSX821 25-30	L0821665721	25	30	153.2	154.2	82.0	117.0	
NSX821 25-35	L0821665751	25	35					
NSX821 25-40	L0821665781	25	40					

For steel chain series: Rexnord: 802 (all), 805 MCC: double hinge.

For plastic chain series: 821, SWH.

NS 821 is a set of 2 NS 881 sprockets;

NSX 821 is a set of 2 NSX 881 idlers.

Classic Sprockets And Idlers, Injection Moulded - N/NX 800

Sprockets, Metric Bores

N800 25-30	L0800666101	25	30	153.2	154.2	89.0	121.5	60
N800 25-35	L0800666121	25	35					
N800 25-40	L0800666131	25	40					

Idlers, Metric Bores

NX800 25-30	L0800666141	25	30	153.2	154.2	89.0	121.5	60
NX800 25-35	L0800666161	25	35					
NX800 25-40	L0800666181	25	40					

For steel chain series: Rexnord: 802 (all), 805 MCC: double hinge.

KU 821

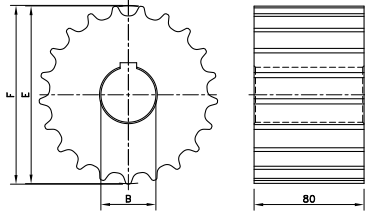

Sprocket Type	Code Number	Number of Teeth	Bore	Pitch Diameter	Outside Diameter	Width (Teeth)	Hub Width	Hub Diameter
			B	E	F	C	A	H
			mm/inch	mm	mm	mm	mm	mm
Classic Sprockets And Idlers, Machined - KU 821								
Sprockets, Metric Bores								
KU821 19-25	753.94.07	19	25	117.3	116.3	80.0	-	-
KU821 19-30	753.94.08	19	30					
KU821 19-35	753.94.09	19	35					
KU821 19-40	753.94.10	19	40					
KU821 19-50	753.94.11	19	50					
KU821 21-25	753.94.13	21	25	129.3	130.0			
KU821 21-30	753.94.14	21	30					
KU821 21-35	753.94.15	21	35					
KU821 21-40	753.94.16	21	40					
KU821 21-50	753.94.17	21	50					
KU821 23-25	753.94.19	23	25	141.2	141.9			
KU821 23-30	753.94.20	23	30					
KU821 23-35	753.94.21	23	35					
KU821 23-40	753.94.22	23	40					
KU821 23-50	753.94.23	23	50					
KU821 25-25	753.94.25	25	25	153.2	153.9			
KU821 25-30	753.94.26	25	30					
KU821 25-35	753.94.27	25	35					
KU821 25-40	753.94.28	25	40					
KU821 25-50	753.94.29	25	50					
KU821 27-25	753.94.31	27	25	165.2	165.9			
KU821 27-30	753.94.32	27	30					
KU821 27-35	753.94.33	27	35					
KU821 27-40	753.94.34	27	40					
KU821 27-50	753.94.35	27	50					
KU821 29-25	753.94.37	29	25	177.2	178.0			
KU821 29-30	753.94.38	29	30					
KU821 29-35	753.94.39	29	35					
KU821 29-40	753.94.40	29	40					
KU821 29-50	753.94.41	29	50					
Idlers, Metric Bores								
KU821 19-25	753.94.47	19	25	117.3	116.3	80.0	-	-
KU821 19-30	753.94.48	19	30					
KU821 19-35	753.94.49	19	35					
KU821 19-40	753.94.50	19	40					
KU821 19-50	753.94.51	19	50					
KU821 21-25	753.94.52	21	25	129.3	130.0			
KU821 21-30	753.94.53	21	30					
KU821 21-35	753.94.54	21	35					
KU821 21-40	753.94.55	21	40					
KU821 21-50	753.94.56	21	50					
KU821 23-25	753.94.57	23	25	141.2	141.9			
KU821 23-30	753.94.58	23	30					
KU821 23-35	753.94.59	23	35					
KU821 23-40	753.94.60	23	40					
KU821 23-50	753.94.61	23	50					
KU821 25-25	753.94.62	25	25	153.2	153.9			
KU821 25-30	753.94.63	25	30					
KU821 25-35	753.94.64	25	35					
KU821 25-40	753.94.65	25	40					
KU821 25-50	753.94.66	25	50					

Sprocket Type	Code Number	Number of Teeth	Bore	Pitch Diameter	Outside Diameter	Width (Teeth)	Hub Width	Hub Diameter
			B	E	F	C	A	H
			mm/inch	mm	mm	mm	mm	mm

Classic Sprockets And Idlers, Machined - KU 821 continued

Idlers, Metric Bores								
KU821 27-25	753.94.67	27	25	165.2	165.9	80.0	-	-
KU821 27-30	753.94.68	27	30					
KU821 27-35	753.94.69	27	35					
KU821 27-40	753.94.70	27	40					
KU821 27-50	753.94.71	27	50	177.2	178.0			
KU821 29-25	753.94.72	29	25					
KU821 29-30	753.94.73	29	30					
KU821 29-35	753.94.74	29	35					
KU821 29-40	753.94.75	29	40					
KU821 29-50	753.94.76	29	50					

For steel chain series: **Rexnord:** 802 (all), 805 MCC: double hinge For plastic chain series: 821, SWH.

Kus 821

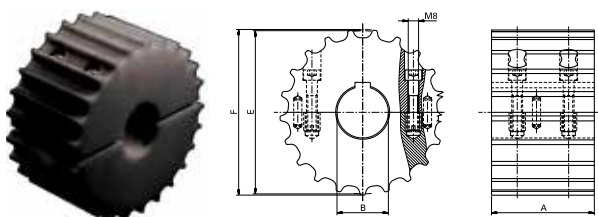

KXT 800

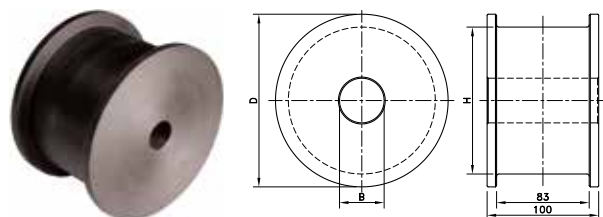

Split Sprockets And Idlers, Machined - KUS 821

Sprockets, Metric Bores								
KUS821 23-25	753.64.71	23	25	141.2	141.9	80.0	-	-
KUS821 23-30	753.64.72	23	30					
KUS821 23-35	753.64.73	23	35					
KUS821 23-40	753.64.74	23	40					
KUS821 23-50	753.64.75	23	50	165.2	165.9			
KUS821 27-25	753.64.91	27	25					
KUS821 27-30	753.64.92	27	30					
KUS821 27-35	753.64.93	27	35					
KUS821 27-40	753.64.94	27	40					
KUS821 27-50	753.64.95	27	50					

Idlers, Metric Bores								
KUS821 23-25	753.64.21	23	25	141.2	141.9	80.0	-	-
KUS821 23-30	753.64.22	23	30					
KUS821 23-35	753.64.23	23	35					
KUS821 23-40	753.64.24	23	40					
KUS821 23-50	753.64.25	23	50	165.2	165.9			
KUS821 27-25	753.64.41	27	25					
KUS821 27-30	753.64.42	27	30					
KUS821 27-35	753.64.43	27	35					
KUS821 27-40	753.64.44	27	40					
KUS821 27-50	753.64.45	27	50					

For steel chain series: **Rexnord:** 802 (all), 805 MCC: double hinge.
For plastic chain series: 821, SWH.

Classic Idler Drums, Machined - KXT 800

Metric Bores								
KXT 800 21-25	L0800605761	21	25*	106.8	129.8	100.0	-	106.8
KXT 800 23-25	L0800605771	23	25*	119.3	142.3			119.3
KXT 800 25-25	L0800605781	25	25*	131.7	154.7			131.7

* Pre-bore.

For steel chain series: **Rexnord:** 802 (all), 805 MCC: double hinge.

NSH 880

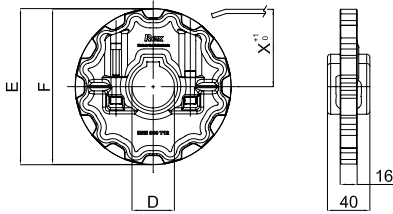

SD RH

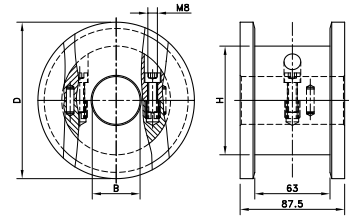

Sprocket Type	Code Number	Number of Teeth	Bore	Pitch Diameter	Outside Diameter	Width (Teeth)	Hub Width	Hub Diameter
			B	E	F	C	A	H
			mm/inch	mm	mm	mm	mm	mm

Split Sprockets Injection Moulded - NSH 880

Sprockets, Metric Bores								
NSH880 12-40	751.90.02	12	40	147.2	147.4	15.9	58.5	60
Sprockets, Inch Bores								
NSH880 12-1½"	751.90.05	12	1.5"	147.2	147.4	15.9	58.5	60

For plastic chain series: 879, 880, RH, RHD, RHM, RHMD, RHMP, RHMDP, SHP

Split Idler Drums, Machined - SD RH

Metric Bores								
SD RH 131-25	754.10.62	10	25	123.3	131.0			
SD RH 131-30	754.10.63	10	30					
SD RH 131-35	754.10.64	10	35					
SD RH 131-40	754.10.65	10	40					
SD RH 131-50	754.10.66	10	50					
SD RH 143-25	754.11.82	11	25	135.2	143.0	87.5	87.5	--
SD RH 143-30	754.11.83	11	30					
SD RH 143-35	754.11.84	11	35					
SD RH 143-40	754.11.85	11	40					
SD RH 143-50	754.11.86	11	50					
SD RH 155-25	754.13.02	12	25	147.2	155.0			
SD RH 155-30	754.13.03	12	30					
SD RH 155-35	754.13.04	12	35					
SD RH 155-40	754.13.05	12	40					
SD RH 155-50	754.13.06	12	50					

For plastic chain series: 879-TAB, 880-TAB, RH, RHD.