

# Straight Run Single Hinge Sideflex Joint Hinge

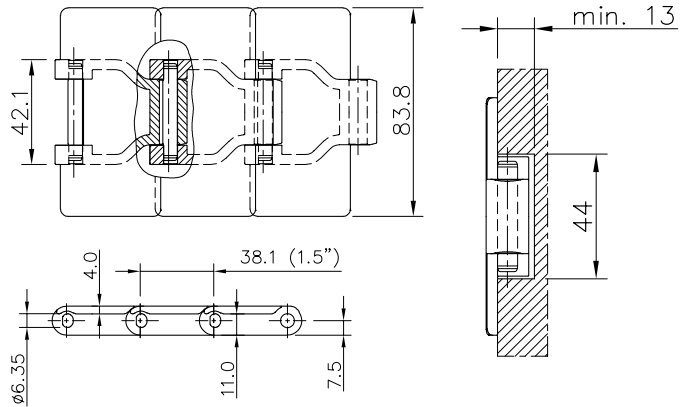

Chain Type	Code Number	Plate Width A		Weight kg/m	Working Load (max.) N (21°C)	Backflex Radius (min) mm	Plate Thickness mm
		mm	inch				
<b>XL-Acetal</b>							
SHP 325 XL	750.10.22	82.5	3.25	0.94	2100	50	4.0
SHP 84 XL	750.12.35	83.8	3.30	0.94			
<b>PSX Advanced Performance Polymer Alloy</b>							
SHP 325 PSX	750.10.46	82.5	3.25	0.94	2100	50	4.0
SHP 84 PSX	750.10.45	83.8	3.30	0.94			

## NXT 820

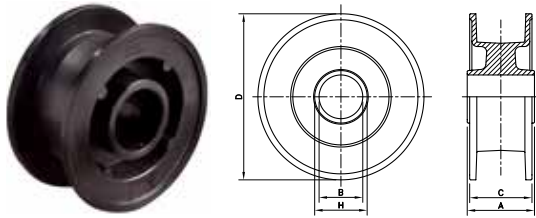

## NSXT 820

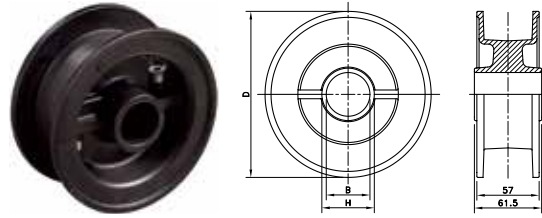

Sprocket Type	Code Number	Number of Teeth	Bore	Pitch Diameter	Outside Diameter	Width (Teeth)	Hub Width	Hub Diameter
			B	E	F	C	A	H
			mm/inch	mm	mm	mm	mm	mm

### Classic Idler Drums, Injection Moulded - NXT 820

Metric Bores								
NXT820 15-25	L0820662461	15	25	--	95.5	55.0	92.0	40
NXT820 15-30	L0820662471	15	30	--	95.5	55.0	92.0	40
NXT820 17-25	L0820661701	17	25	--	106.5	53.0	57.0	42
NXT820 17-30	L0820661711	17	30	--	106.5	53.0	57.0	42
NXT820 18-25	L0820661801	18	25	--	113.0	57.0	92.0	40
NXT820 18-30	L0820661811	18	30	--	113.0	57.0	92.0	40
NXT820 19-25	L0820661471	19	25	--	118.0	57.0	57.0	42
NXT820 19-30	L0820661481	19	30	--	118.0	57.0	57.0	42
NXT820 19-40	L0820661491	19	40	--	118.0	57.0	57.0	51
NXT820 21-25	L0820662091	21	25	--	130.0	60.0	61.5	35
NXT820 21-30	L0820662101	21	30	--	130.0	60.0	61.5	40
NXT820 21-35	L0820662121	21	35	--	130.0	60.0	61.5	45
NXT820 21-40	L0820662111	21	40	--	130.0	60.0	61.5	50
NXT820 23-25	L0820661821	23	25	--	142.5	59.5	61.5	35
NXT820 23-30	L0820661831	23	30	--	142.5	59.5	61.5	40
NXT820 23-35	L0820661861	23	35	--	142.5	59.5	61.5	45
NXT820 23-40	L0820661841	23	40	--	142.5	59.5	61.5	50
NXT820 25-25	L0820661721	25	25	--	154.5	59.0	61.5	35
NXT820 25-30	L0820661731	25	30	--	154.5	59.0	61.5	40
NXT820 25-35	L0820661741	25	35	--	154.5	59.0	61.5	45
NXT820 25-40	L0820661751	25	40	--	154.5	59.0	61.5	50
Inch Bores								
NXT820 21-1	L0820619132	21	1.00"	--	130.0	60.0	61.5	35
NXT820 21-1¼	L0820688801	21	1.25"	--	130.0	60.0	61.5	40
NXT820 21-1½	L0820688811	21	1.50"	--	130.0	60.0	61.5	45
NXT820 23-1¼	L0820661891	23	1.25"	--	142.5	59.5	61.5	40
NXT820 23-1½	L0820661881	23	1.50"	--	142.5	59.5	61.5	45
NXT820 25-1	L0820619142	25	1.00"	--	154.5	59.0	61.5	35
NXT820 25-1¼	L0820661761	25	1.25"	--	154.5	59.0	61.5	40
NXT820 25-1½	L0820661771	25	1.50"	--	154.5	59.0	61.5	45

For steel chain series: **Rexnord**: 812 (except TAB and mini hinge), 815, 881 (except TAB), 8811 (except TAB).

**MCC**: single hinge straight run, single hinge Magnetflex.

For plastic chain series: 879-Bevel, 880-Bevel, 820, 831, SH, SHD, RHM, RHMD,RHMP, RHMDP, SHP.

### Split Idler Drums, Injection Moulded - NSXT 820

Metric Bores								
NSXT 820 21-25	L0820665821	21	25	--	130.0	57.0	61.5	40
NSXT 820 21-30	L0820664861	21	30	--	130.0	57.0	61.5	40
NSXT 820 21-35	L0820664881	21	35	--	130.0	57.0	61.5	50
NSXT 820 21-40	L0820665841	21	40	--	130.0	57.0	61.5	50
NSXT 820 23-25	L0820665861	23	25	--	142.5	57.0	61.5	40
NSXT 820 23-30	L0820665881	23	30	--	142.5	57.0	61.5	40
NSXT 820 23-35	L0820665901	23	35	--	142.5	57.0	61.5	50
NSXT 820 23-40	L0820665921	23	40	--	142.5	57.0	61.5	50
NSXT 820 25-25	L0820665591N	25	25	--	154.5	57.0	61.5	35
NSXT 820 25-30	L0820665941N	25	30	--	154.5	57.0	61.5	40
NSXT 820 25-35	L0820665961N	25	35	--	154.5	57.0	61.5	45
NSXT 820 25-40	L0820664901N	25	40	--	154.5	57.0	61.5	50
NSXT 820 25-45	L0820697961N	25	45	--	154.5	57.0	61.5	50

# NSH 880

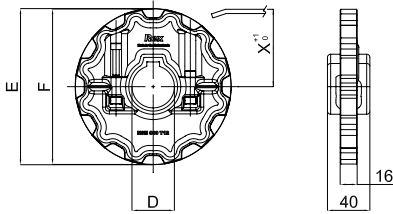

# SD RH

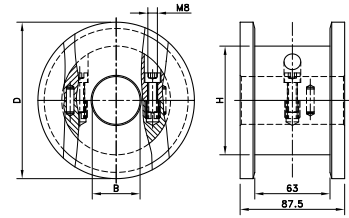

Sprocket Type	Code Number	Number of Teeth	Bore	Pitch Diameter	Outside Diameter	Width (Teeth)	Hub Width	Hub Diameter
			B	E	F	C	A	H
			mm/inch	mm	mm	mm	mm	mm

### Split Sprockets Injection Moulded - NSH 880

Sprockets, Metric Bores								
NSH880 12-40	751.90.02	12	40	147.2	147.4	15.9	58.5	60
Sprockets, Inch Bores								
NSH880 12-1½"	751.90.05	12	1.5"	147.2	147.4	15.9	58.5	60

For plastic chain series: 879, 880, RH, RHD, RHM, RHMD, RHMP, RHMDP, SHP

### Split Idler Drums, Machined - SD RH

Metric Bores								
SD RH 131-25	754.10.62	10	25	123.3	131.0			
SD RH 131-30	754.10.63	10	30					
SD RH 131-35	754.10.64	10	35					
SD RH 131-40	754.10.65	10	40					
SD RH 131-50	754.10.66	10	50					
SD RH 143-25	754.11.82	11	25	135.2	143.0	87.5	87.5	--
SD RH 143-30	754.11.83	11	30					
SD RH 143-35	754.11.84	11	35					
SD RH 143-40	754.11.85	11	40					
SD RH 143-50	754.11.86	11	50					
SD RH 155-25	754.13.02	12	25	147.2	155.0			
SD RH 155-30	754.13.03	12	30					
SD RH 155-35	754.13.04	12	35					
SD RH 155-40	754.13.05	12	40					
SD RH 155-50	754.13.06	12	50					

For plastic chain series: 879-TAB, 880-TAB, RH, RHD.

**SS/SI RH**

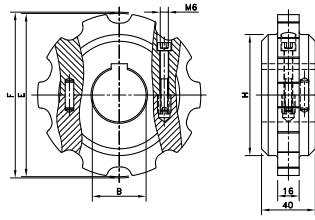

**NS(X) 880**

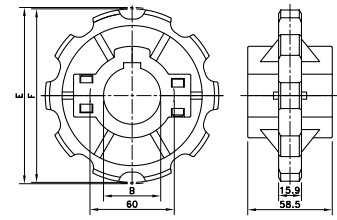

Sprocket Type	Code Number	Number of Teeth	Bore	Pitch Diameter	Outside Diameter	Width (Teeth)	Hub Width	Hub Diameter
			B	E	F	C	A	H
			mm/inch	mm	mm	mm	mm	mm

**Split Sprockets And Idlers, Machined - SS/SI RH**

Sprockets, Metric Bores												
SS RH 9-25	754.60.51	9	25	111.4	109.0	16.0	40.0	75				
SS RH 9-30	754.60.52	9	30									
SS RH 9-35	754.60.53	9	35									
SS RH 9-40	754.60.54	9	40	123.3	121.4			16.0	40.0	90		
SS RH 10-25	754.60.61	10	25									
SS RH 10-30	754.60.62	10	30									
SS RH 10-35	754.60.63	10	35	135.2	133.9					16.0	40.0	90
SS RH 10-40	754.60.64	10	40									
SS RH 11-25	754.60.71	11	25									
SS RH 11-30	754.60.72	11	30	147.2	145.8	16.0	40.0					90
SS RH 11-35	754.60.73	11	35									
SS RH 11-40	754.60.74	11	40									
SS RH 12-25	754.60.81	12	25	147.2	145.8			16.0	40.0			90
SS RH 12-30	754.60.82	12	30									
SS RH 12-35	754.60.83	12	35									
SS RH 12-40	754.60.84	12	40									

Idlers, Metric Bores												
SI RH 9-25	754.60.01	9	25	111.4	109.0	16.0	40.0	75				
SI RH 9-30	754.60.02	9	30									
SI RH 9-35	754.60.03	9	35									
SI RH 9-40	754.60.04	9	40	123.3	121.4			16.0	40.0	90		
SI RH 10-25	754.60.11	10	25									
SI RH 10-30	754.60.12	10	30									
SI RH 10-35	754.60.13	10	35	135.2	133.9					16.0	40.0	90
SI RH 10-40	754.60.14	10	40									
SI RH 11-25	754.60.21	11	25									
SI RH 11-30	754.60.22	11	30	147.2	145.8	16.0	40.0					90
SI RH 11-35	754.60.23	11	35									
SI RH 11-40	754.60.24	11	40									
SI RH 12-25	754.60.31	12	25	147.2	145.8			16.0	40.0			90
SI RH 12-30	754.60.32	12	30									
SI RH 12-35	754.60.33	12	35									
SI RH 12-40	754.60.34	12	40									

For plastic chain series: 879, 880, RH, RHD, RHM, RHMD, RHMP, RHMDP, SHP

**Split Sprockets and Idlers, Injection Moulded - NS(X) 880**

Sprockets, Metric Bores										
NS880 10-25	L0880662171	10	25	123.3	122.5	15.9	58.5	60		
NS880 10-30	L0880662211	10	30							
NS880 10-35	L0880662251	10	35							
NS880 10-40	L0880662291	10	40							
NS880 10-45	L0880662331	10	45	147.2	147.4			15.9	58.5	60
NS880 12-25	L0880663151	12	25							
NS880 12-30	L0880663161	12	30							
NS880 12-35	L0880663171	12	35							
NS880 12-40	L0880663181	12	40	147.2	147.4	15.9	58.5			60
NS880 12-45	L0880663191	12	45							

Sprockets, Inch Bores								
NS880 12-1	L0880663201	12	1.000"	147.2	147.4	15.9	58.5	60
NS880 12-1¼	L0880663241	12	1.250"					

Idlers, Metric Bores										
NSX880 10-25	L0880662401	10	25	123.3	122.5	15.9	58.5	60		
NSX880 10-30	L0880662421	10	30							
NSX880 10-35	L0880662441	10	35							
NSX880 10-40	L0880619422	10	40							
NSX880 12-25	L0880604082	12	25	147.2	147.4			15.9	58.5	60
NSX880 12-30	L0880604092	12	30							
NSX880 12-35	L0880699811	12	35							
NSX880 12-40	L0880604602	12	40							

For plastic chain series: 879, 880, RH, RHD, RHM, RHMD, RHMP, RHMDP, SHP.

\* Ask Customer service for minimum order quantity of NS880 sprockets with inch bores.