

1757 TAB with Rubber

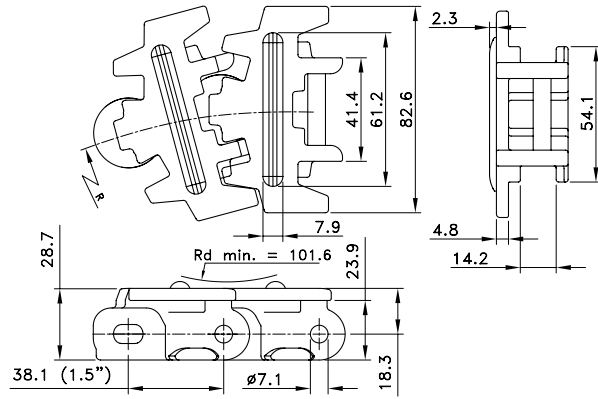

Chain Type	Code Number	Link Width A		Weight kg/m	Working Load (max.) N (21°C)	Backflex Radius (min) mm	Sideflex Radius (min) mm
		mm	inch				
HP-Acetal							
HPM 1757 TAB	81421361*	82,6	3,25	1,48	1735	102	152

Standard length: 3.048 m - 10 feet (80 links).
 * Minimum order quantity 30.48 m - 100 feet.

ZN 1700

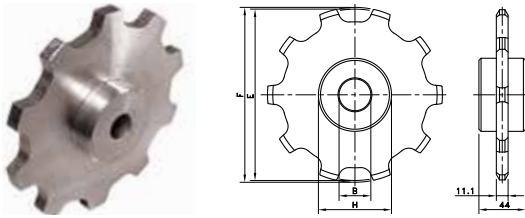

GG1757

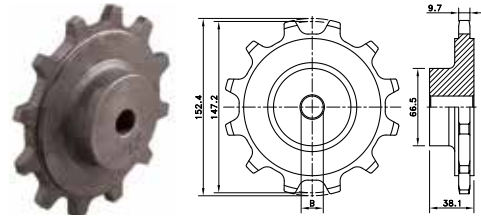

Sprocket Type	Code Number	Number of Teeth	Bore	Pitch Diameter	Outside Diameter	Width (Teeth Ring)	Hub Width	Hub Diameter
			B	E	F			
Classic Zinc Plated Steel Idlers - ZN 1700								
Metric Bores								

ZN1700 10-20	L1700661421	10	20	161.8	165.1	11.1	44.0	69.0
ZN1700 12-20	L1700661431	12	20	193.2	196.1			

For Multiflex chain series: 1700, 1702, 1710, 1713, 1720, 1765.

Classic Semi-Steel Sprocket, Excentered Hub - GG 1757

Inch Bores

GG1757 12- 3/4 prebore	414-36-2	12	0.750"	147.2	152.4	9.7	38.1	66.5
------------------------	----------	----	--------	-------	-------	-----	------	------

For Multiflex chain series: 1757

NXT 1757

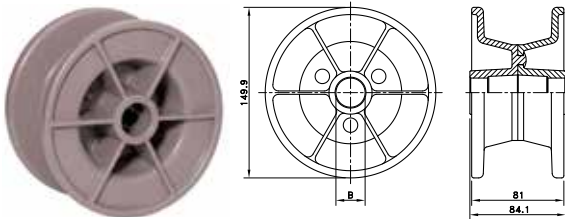

KUS 2500

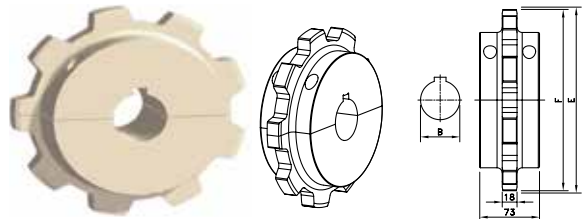

Classic Plastic Idler Drum, Injection Moulded - NXT 1757

Metric Bores

NXT1757 10-25	614-25-1	10	25	-	149.9	81	84.1	38.1
---------------	----------	----	----	---	-------	----	------	------

For Multiflex chain series: 1757.

Split Plastic Sprockets, Injection Moulded - KUS 2500

Metric Bores

KUS 2500 T09 R50	614-681-8	9	50	222.8	221.2	18.0	73.0	165.0
------------------	-----------	---	----	-------	-------	------	------	-------

For Multiflex chain series: 2565.

KUS 1775

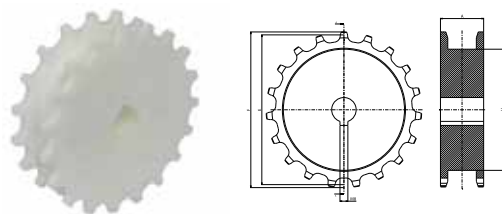

KUS 1780

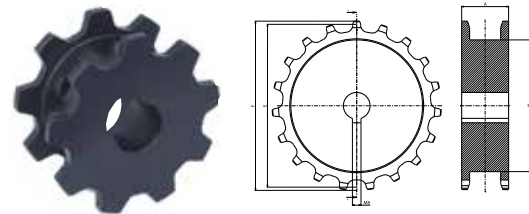

Split Plastic Sprockets, Machined - KUS 1755

Metric Bores

KUS1775 19-25	L1775611316	19	25	151.9	157.9	7.4	43.8	112.9
---------------	-------------	----	----	-------	-------	-----	------	-------

For Multiflex chain series: 1775

Split Plastic Sprockets, Machined - KUS 1780

Metric Bores

KUS1780 09-40	L1780609826	9	40	140.34	146	9	70	-
---------------	-------------	---	----	--------	-----	---	----	---

For Multiflex chain series: 1785.