

# 1720

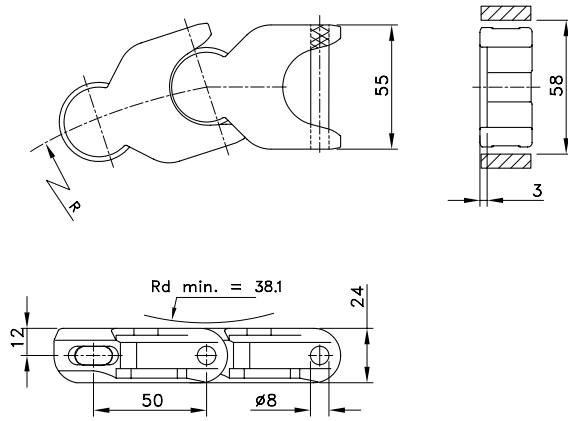

Chain Type	Code Number	Link Width A		Weight kg/m	Working Load (max.) N (21°C)	Backflex Radius (min) mm	Sideflex Radius (min) mm
		mm	inch				
<b>HP-Acetal</b>							
HP 1720	L1720HP	55.0	2.17	1.26	2600	50	140

Standard length: 10 m - 32.8 feet (200 links).

## N 1700

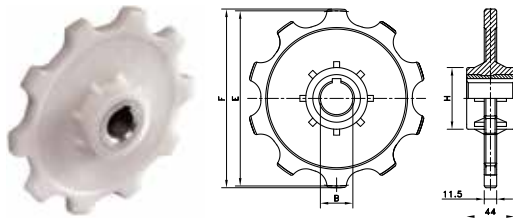

## NX 1700

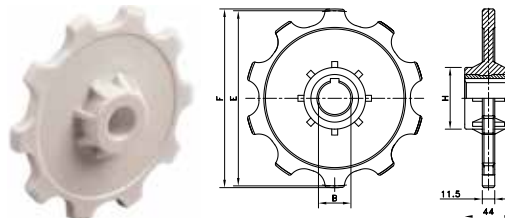

Sprocket Type	Code Number	Number of Teeth	Bore	Pitch Diameter	Outside Diameter	Width (Teeth Ring)	Hub Width	Hub Diameter
			B	E	F	mm	mm	mm

### N 1700 - Classic Plastic Sprockets, Injection Moulded, Brass Hub

Metric Bores								
N1700 10-24	L1700661391	10	24	161.8	165.1	11.1	44.0	57
N1700 10-25	L1700661381	10	25					
N1700 10-30	L1700661401	10	30					

For Multiflex chain series: 1700, 1702, 1710, 1713, 1720, 1765.

### NX 1700 - Classic Plastic Idler, Injection Moulded

Metric Bores								
NX1700 10-25	L1700661411	10	25	161.8	165.1	11.1	43.0	50

For Multiflex chain series: 1700, 1702, 1710, 1713, 1720, 1765.

## KU 1700

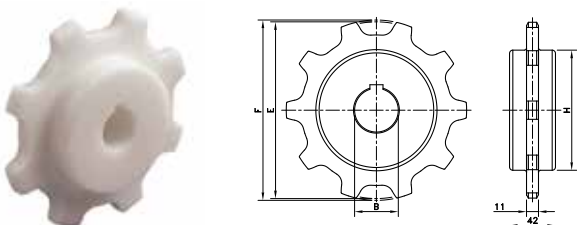

## KU 1775

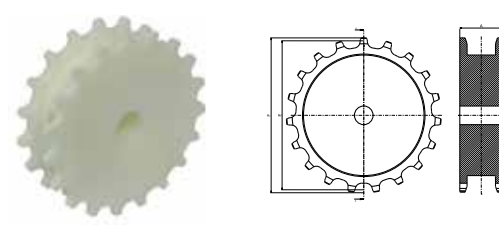

### KU 1700 - Classic Plastic Sprockets, Machined

Metric Bores								
KU1700 08-19	L1700668341	8	19	130.7	132.8	11.1	42.0	79
KU1700 08-25	L1700613242	8	25					
KU1700 08-30	L1700630842	8	30					
KU1700 10-19	L1700668351	10	19	161.8	165.1	11.1	42.0	110
KU1700 10-25	L1700602806	10	25					
KU1700 10-30	L1700618392	10	30					
KU1700 13-19	L1700668361	13	19	209.0	215.2	11.1	42.0	158

For Multiflex chain series: 1700, 1702, 1710, 1713, 1720, 1765

### KU 1775 - Classic Plastic Sprockets, Machined

Metric Bores								
KU1775 19-19	L1775635523	19	25	151,9	157,9	7.4	43.8	112.9

For Multiflex chain series: 1775.

## ZN 1700

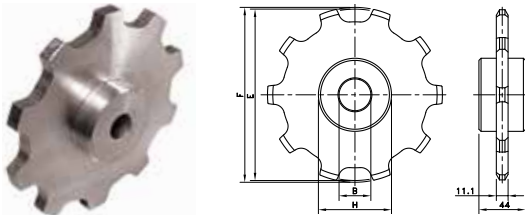

## GG1757

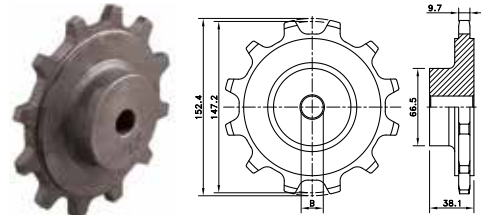

Sprocket Type	Code Number	Number of Teeth	Bore	Pitch Diameter	Outside Diameter	Width (Teeth Ring)	Hub Width	Hub Diameter
			B	E	F			
			mm	mm	mm	mm	mm	mm

### Classic Zinc Plated Steel Idlers - ZN 1700

#### Metric Bores

ZN1700 10-20	L1700661421	10	20	161.8	165.1	11.1	44.0	69.0
ZN1700 12-20	L1700661431	12	20	193.2	196.1			

For Multiflex chain series: 1700, 1702, 1710, 1713, 1720, 1765.

### Classic Semi-Steel Sprocket, Excentered Hub - GG 1757

#### Inch Bores

GG1757 12- 3/4 prebore	414-36-2	12	0.750"	147.2	152.4	9.7	38.1	66.5
------------------------	----------	----	--------	-------	-------	-----	------	------

For Multiflex chain series: 1757

## NXT 1757

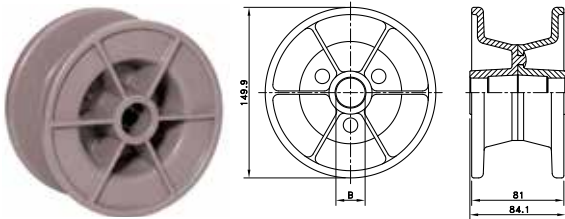

## KUS 2500

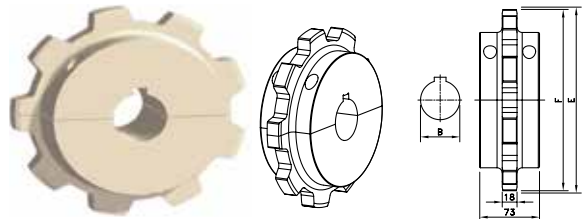

### Classic Plastic Idler Drum, Injection Moulded - NXT 1757

#### Metric Bores

NXT1757 10-25	614-25-1	10	25	-	149.9	81	84.1	38.1
---------------	----------	----	----	---	-------	----	------	------

For Multiflex chain series: 1757.

### Split Plastic Sprockets, Injection Moulded - KUS 2500

#### Metric Bores

KUS 2500 T09 R50	614-681-8	9	50	222.8	221.2	18.0	73.0	165.0
------------------	-----------	---	----	-------	-------	------	------	-------

For Multiflex chain series: 2565.

## KUS 1775

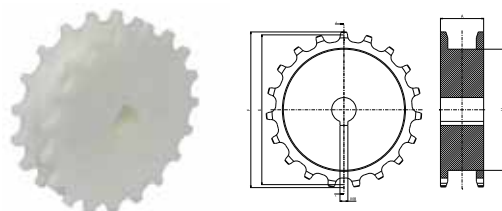

## KUS 1780

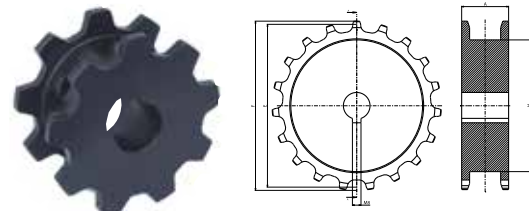

### Split Plastic Sprockets, Machined - KUS 1755

#### Metric Bores

KUS1775 19-25	L1775611316	19	25	151.9	157.9	7.4	43.8	112.9
---------------	-------------	----	----	-------	-------	-----	------	-------

For Multiflex chain series: 1775

### Split Plastic Sprockets, Machined - KUS 1780

#### Metric Bores

KUS1780 09-40	L1780609826	9	40	140.34	146	9	70	-
---------------	-------------	---	----	--------	-----	---	----	---

For Multiflex chain series: 1785.

# ND1700 B

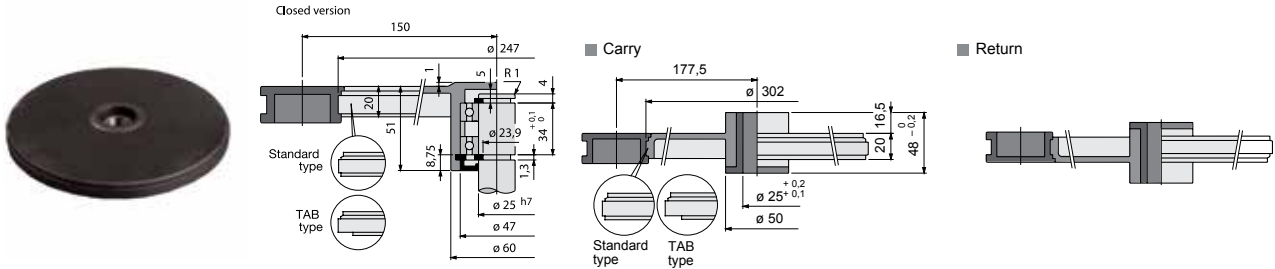

Corner Disc Type	Code Number	Execution	Open/ Closed	Pitch Diameter Chain	Outside Diameter	Weight
				mm	mm	kg

For Plastic Multiflex Chains 1700 K, 1710 K, 1720 K and 1765 Zerogap

### Corner Discs including bearings

ND1775	L0000649193	carry	open	300	247	0.70
ND1700BC-TR	L1700669701	carry	closed			
ND1700BO-TR	L1700669721	carry	open			
ND1700BC-RET	L1700669611	return	closed			
ND1700BO-RET	L1700669641	return	open			

- prepared for 2x single race ball bearing (25x47x12 mm).

# ND1700 FL

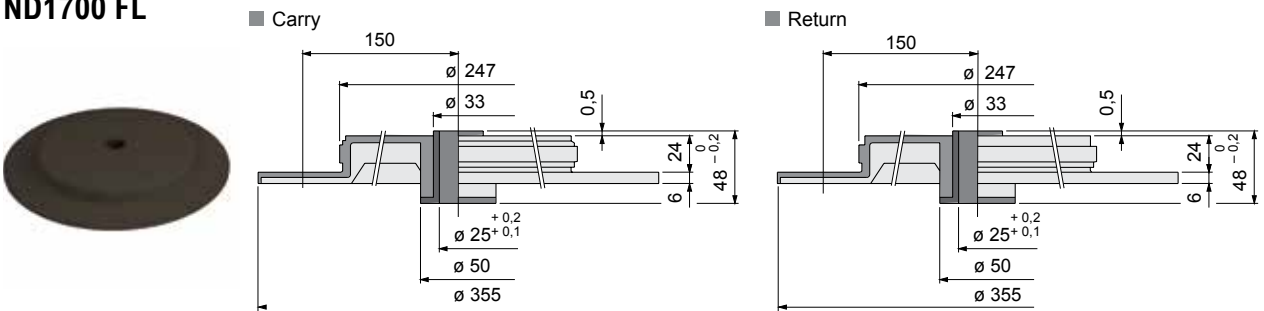

### Corner Discs without bearings

ND1700-TR	L1700669561	carry	open	300	247	0.47
ND1700-RET	L1700669591	return	open			

### With Flanges (Ø355)

ND1700FL-TR	L1700689461	carry	open	300	247	0.92
ND1700FL-RET	L1700609602	return	open			

- plastic bushing diameter  $\varnothing 25$  mm.

# ND1700 TB

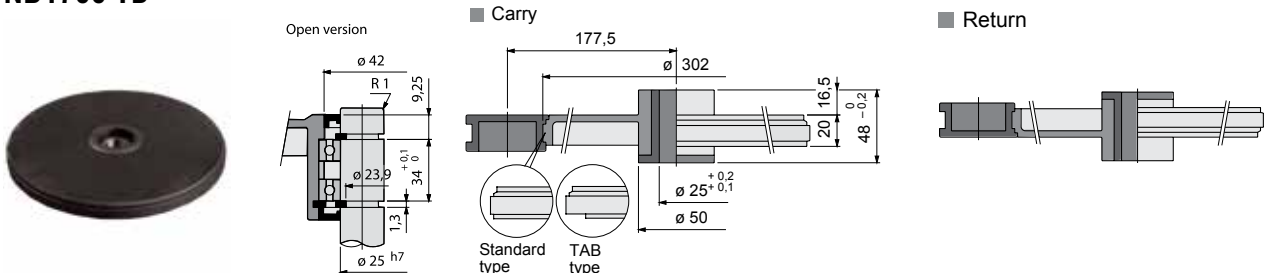

### Corner Disc including bearings

#### Standard

ND1700TBC-TR	L1700669741	carry	closed	300	247	0.70
ND1700TBO-TR	L1700669761	carry	open			
ND1700TBC-RET	L1700669661	return	closed			
ND1700TBO-RET	L1700669681	return	open			

- prepared for 2x single race ball bearing (25x47x12 mm)

### Corner Disc without bearings

ND1700T-TR	L1700669571	carry	open	300	247	0.47
ND1700T-RET	L1700669601	return	open			

- plastic bushing diameter  $\varnothing 25$  mm.